

Twin matter against dark matter

Jean-Pierre Petit, Pierre Midy and Frederic Landsheat

Marseille Observatory, France

jppetit1937@yahoo.fr

International Conference on Astrophysics and Cosmology "Where is the matter?"
Marseille, France, June 25-29, 2001

Abstract

Recent 3d mapping of dark matter (Fort and Meillier, 1999) implies the existence of "dark clusters", which would be exclusively composed by dark matter. Exploring a new way, one assume in a first step that dark matter owns a negative mass and energy and shows it fits observational data: VLS, spiral structure formation, confinement and rotation curves of galaxies, gravitational lensing. By passing it suggests a possible scenario for galaxies' formation. A new geometrical description of matter-dark matter couple is proposed, through a two-points cover of a M4 manifold, forming a two folds (F , \underline{E}) space-time structure. The fold \underline{E} is called the twin fold (Sakharov 1967) and the matter it contains is called the twin matter. In such geometrical background matter and (negative mass and energy) twin matter interact only through gravitational forces, the last one being optically invisible from our fold of the Universe. Our world and the twin world being disconnected this prevents encounters between opposite energy particles. Group theory shows that matter-antimatter duality holds in the twin universe and that it is filled by CPT and PT-symmetrical matter, so that the Feynman PT-symmetrical antimatter is nothing but the antimatter of the twin fold, while CPT-symmetrical composes its matter, going backwards in time, enantiomorphic, and owing opposite electric charge. We present a coupled field equations system. Exact solutions are derived, including spherically symmetric one, similar to Schwarzschild. We get conjugated geometries, with opposite scalar curvatures $\underline{R} = -R$. It is shown that the presence of twin matter in an adjacent portion of space creates *induced* local negative curvature in our fold, which goes with negative gravitational lensing effect. Comparizon with observational data is discussed. As a cosmological model the couple universe-twin universe shows different histories. The twin matter acts as a repulsive matter and accelerates the expansion of our universes, playing the role of a "cosmological constant". Conversely the expansion of the twin in slowed down. For radiative era we develop a variable speed of light model, which ensures the homogeneity of the early univiers: the inflation hypothesis is no longer necessary. Time's nature is discussed. In Newtonian approximation, joint gravitational instability theory is developed, based on two coupled Jeans-like equations. Starting from the TOV equation, we build a model of sleaking neutron star (SNS) in which a central space bridge, connecting fold F and \underline{E} , drains off any excess of matter in the twin space, preventing geometrical criticity. This challenges black hole model, whose validity is contested on theoretical grounds.

1- Introduction

Dark matter is now the unique answer to any astrophysical problem. It ensures the confinement of galaxies, shapes their rotation curves, is responsible on the observed strong gravitational lensing effects, shapes the VLS. A today's specialist in galactic dynamics deposits ad hoc dark matter distribution in each galaxy, in order to fit its observational rotation curve, which is now known with good accuracy, due to the efforts of many observers. But galactic dynamics, as conceived by men like Oort, Chandrasekhar, based on the joint resolution of Vlasov and Poisson equations is now an empty box. The law of physics become fuzzy. In order to explain the problem due to new evaluation of the Hubble's constant, theoreticians reactivate the so-called cosmological constant, while physicists wonder where the "repulsive power of vacuum" comes from. Astronomy shows a strange paradox: the observations become more and more precise, richer and sophisticated each year but nobody knows how a galaxy works and forms. The contemporary epoch is devoted to the discovery of the invisible. As the Machos' research finally failed, after ten years' effort, all speculations are now considered, the goal being to discover what dark matter is made of. Several research teams stake on the (indirect) observation of the neutralino, an exotic particle which is supposed to come from the supersymmetry's world and depends on 120 free parameters (seven, the specialists say, with some convenient and reasonable assumptions). Active search of "astroparticles" starts everywhere, in new labs. In France, Fort and Meillier have recently "mapped" dark matter, basing their study on the observed gravitational lensing effects. Since 1989 they have built an adequate method. They presented [1], march 2000, a 3d map of some portion of the Universe, showing the invisible, the underlying dark matter. But in 1994 the first discrepancy arises [2]. The two French researchers discover a portion of the sky where their analysis locates a large concentration of matter, desperately dark. In 1998 a new picture, from the CFHT shows the same phenomenon, near by the Abell 142 galaxies' cluster. See figure 1.

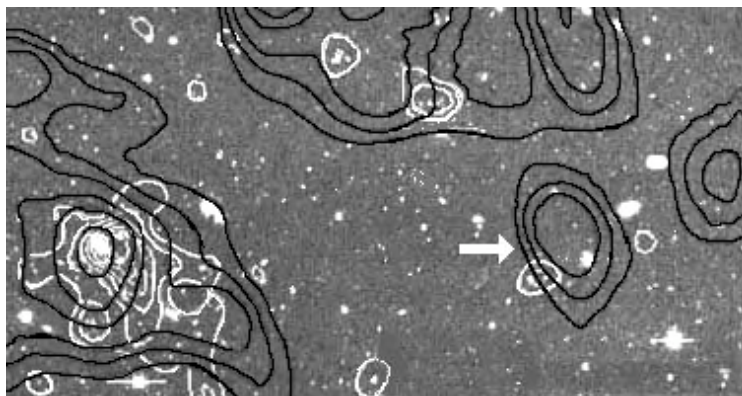

Fig.1: Arrow: the (dark) portion of the sky where the analysis of Fort and Meillier locates a concentration of dark matter equivalent to $5 \cdot 10^{14}$ solar mass. The border of the exotic dark matter cluster is indicated by closed dark loops.

Puzzled, in order to clear up the problem, they decide to make new observations in different light frequencies. But this result is confirmed. If their method is correct a "dark cluster" lies there. As said Fort, interviewed in June 1999 [2]: "It seems difficult to me to think that such huge concentration of dark matter would have captured no galaxy nor gas". As their study refers to a square degree portion of the sky, it means that astrophysicists will have, in the future, when the whole sky will have been mapped with their method, to deal with some 10,000 "dark clusters". This shows that the question of the dark matter is far to be clear, today. There is a room for challenging approaches.

2- What about negative masses and energies?

Can Universe contain both positive and negative masses, obviously owing negative energy? Today, all speculations about "exotic particles" are allowed. In a first step let us assume than our Universe is a mixture of positive and negative masses and see what happens. We can assume that this negative energy matter corresponds to some sort of an exotic matter, which would interact with ordinary matter only though gravitational force, emit and capture no photon (i.e. this matter would be dark and invisible). Later we deal with another hypothesis, implying an "exotic geometry" (section 8). Let us choose the laws of interaction (which will be justified latter too, in section 12).

- positive masses attracts each other through Newton law.
- negative masses attract each other through Newton law.
- a positive mass m and a negative mass \underline{m} repel each other through "anti-Newton law".

Former results were published in Nuevo Cimento in 1994 [3]. The two population separate, experiencing joint gravitational instabilities.

3- 2d simulation of the VLS in terms of interaction of two populations, with opposite masses.

In 1970 Zel'dovich proposed his well-known pancakes theory [5]. The pancake effect was first demonstrated by Doroshkevich and al.[6], Klypin and Shandarin [7] , and Centrella & Mellot [8]. Mellot and Shandarin (1990)] gave an elegant demonstration of the effect by using two-dimensional computations that afforded considerably better resolution for a given particle number [9]. Shandarin, Kofman and Pogosyan presented a powerful semi-analytic method for predicting the positions of pancakes from the initial conditions [10] & [11]. More recently Mellot used a 3d set of 643 particles, with periodic boundary conditions. From Mellot, the density fluctuations remain small. As pointed out by Peebles [12] "This cannot be the whole story, for the pancakes found are a transient effect: with increasing time the mass in the pancakes drains into clumps that are concentrated in all the three dimensions. This means that if the local sheet of galaxies was a pancake, it must have been formed recently". Then Peebles asked: "could there be a second generation of pancakes that formed out of the first generation?" But he concluded immediately: "This does not follow from the analysis given here, for it depends on the continuity of the velocity field that allows to write down a series expansion for the evolution of the relative positions. After the formation of the first generation of clumps, which might be the galaxies or their progenitors, the velocity field in general does not have the coherence length, and the analysis from the continuity does not apply". As a conclusion the pancake theory cannot describe, in the present state, the observed large structure, so that let us try something else: we take initial condition with uniform mass distributions for normal matter (that we simply call matter) and twin matter. ρ being the mass density of the matter and $\underline{\rho}$ the mass-distribution of the twin matter, we choose for initial conditions $|\underline{\rho}_0| = 64 \rho_0$. At this level, just see what happens. We have performed 2d numerical simulations with two sets of 5000 mass-points, that are supposed to represent some clusters of matter and twin matter, with masses $M > 0$ and $\underline{M} < 0$ (which means that $|\underline{M}| = 64 M$). We give these two sets maxwellian distributions of 2d thermal velocities with $\langle \underline{V} \rangle = 4 \langle V \rangle$. We neglect the expansion phenomena (it would be very difficult to deal with, for we do not know how to describe gravitational force in an expanding universe). The result is the following. The more massive population, the twin matter's one, whose Jeans time is eight times shorter than the other one's runs the game and forms clumps, through gravitational instability, that repel and confines the other population in the remnant place. We get a 2d-cellular structure. The characteristic birth time of the whole structure is close to the Jeans time of the heavier population (of the negative mass matter, the twin matter).

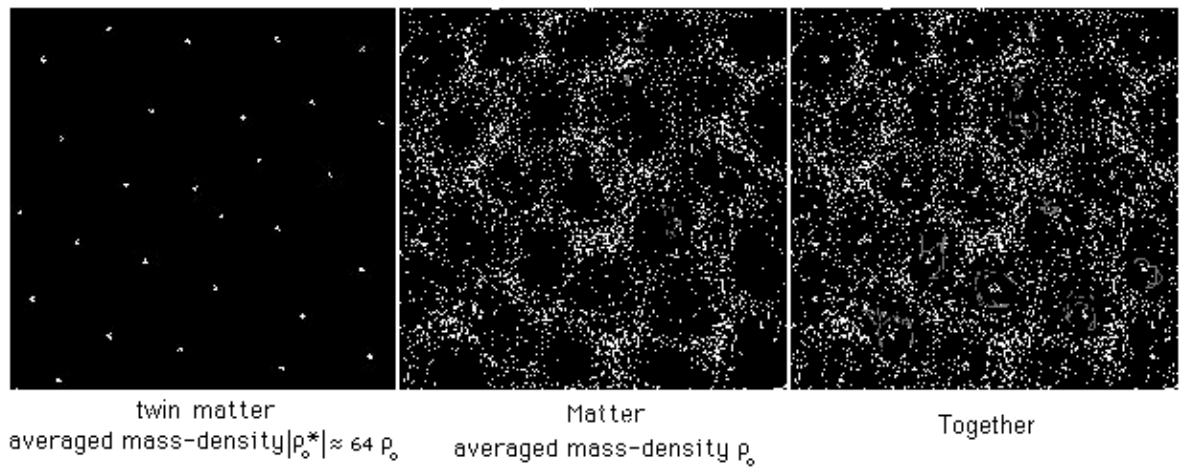

Fig. 2: Results of simulations performed by F.Lansheat.
Left: twin matter clumps. Right: matter structure.

These 2d simulations are remarkably stable in time. Of course, they are 2d simulations, so that we must consider this result as an illustration of an idea. 3d simulation are far beyond the capabilities of our computational system. But we think that, in 3d, we would get 3d cells, looking like joint soap bubbles, centred around negative mass clusters. The general pattern depends on the initial conditions. The larger the twin matter temperature, the bigger are the clumps. This approach, aiming at a modelisation of the very large scale structure of the Universe, is fundamentally different from the classical approaches based on the dark matter. In classical matter-dark matter systems, stability is problematic: gravitational instability, by rising up the density locally, increases the thermal velocities and makes the observed structures to disappear in time. The system with two repelling populations is qualitatively different, each population creating a potential barrier for the other one. This explains the great stability in time and space: the cells of matter keep the clumps of twin matter in place, and the clumps prevent the dissipation of the cellular structure.

On figure 5, call d the diameter of a cell and ϕ the diameter of a clump. For different given initial conditions, and randomized initial positions of mass-points, the number of clumps n_c (and cells on the screen) does not change so much. The standard deviation obeys (a). Same thing for the masses and diameters of the clumps (b), (c)

(a) $\sigma_{n_c} \ll n_c$	(g) $\frac{T_e^* \text{ in the interclump's space}}{T_s \text{ (averaged temperature of matter in the spongy structure)}} \approx 4$	
(b) $\sigma_{m_c} \ll \langle m_c \rangle$		
(c) $\sigma_\phi \ll \langle \phi \rangle$	(h) $n = \frac{1}{d^3}$	(l) $\rho(r, \phi, d) = e^{-\frac{r}{\lambda}} = e^{-\frac{\pi \phi^2 r}{4 d^3}}$
(d) $\frac{\rho_e^*}{\rho_s} \approx 4$	(i) $\frac{\pi \phi^2}{4}$	(m) $\alpha = \frac{\phi}{d}$
(e) $\frac{\phi}{d} \approx 0.14$	(j) $v = \frac{\pi \phi^2 c}{4 d^3}$	(n) $x = \frac{r}{d}$
(f) $T \approx \langle V_x^2 + V_y^2 + V_z^2 \rangle$	(k) $\lambda = \frac{c}{v} = \frac{4 d^3}{\pi \phi^2}$	(o) $\rho(\alpha, x) = e^{-\frac{\pi \alpha^2 x}{4}}$

We can examine some features, for this peculiar numerical computation. Matter forms a cellular

structure. Call ρ_s the mean mass density of matter in that structure. Outside the clumps, the twin matter has a constant density (subscript e, for "external"), corresponding to (d)..The mean diameter of the clumps, compared to the mean diameter of the cells, obeys (e). We define some sort of "pseudo-temperature", as a measure of the mean kinetic energy in these 2d gazes (f). Where we have (g). T refers to a temperature (of a gas of matter) before galaxies' formation. Can we estimate the effect of these hypothetic twin matter clumps on the light coming from distant sources? A photon, located in our fold of the universe, cannot be captured by a twin matter particle, on pure geometric grounds. But twin matter clumps act on the photon's paths by negative gravitational lensing. Can the presence of twin matter clumps be evidenced by some cosmological test? We can build a rough evaluation, taking a non-realistic situation where the universe is described as euclidean and steady, that would fit moderate distances. The diameters Φ of the twin matter clumps are very similar. As seen before, the standard deviations are weak so that we can figure space, over large distances, as a regular distribution of cells, with a spheroidal clump nested at the centre of each cell, and we can take the same diameter Φ for all clumps. Call n the number of density of the clumps, assumed to be constant over space (h). A photon travels with the velocity c. The cross-section of a clump is (i). The encounter frequency is (remember that the photon cannot be absorbed by the clumps) (j). The mean free path is (k). Can we size the number of galaxies whose image would be altered by negative lensing effect, at a given distance r? From kinetic theory we know how to compute the probability to observe a free path of a given length r. It is (l). Let (m) + (n) then (o). p strongly depends on the value of α . The probability η to get a gravitational lensing effect is $1 - p$, which correspond to the curves:

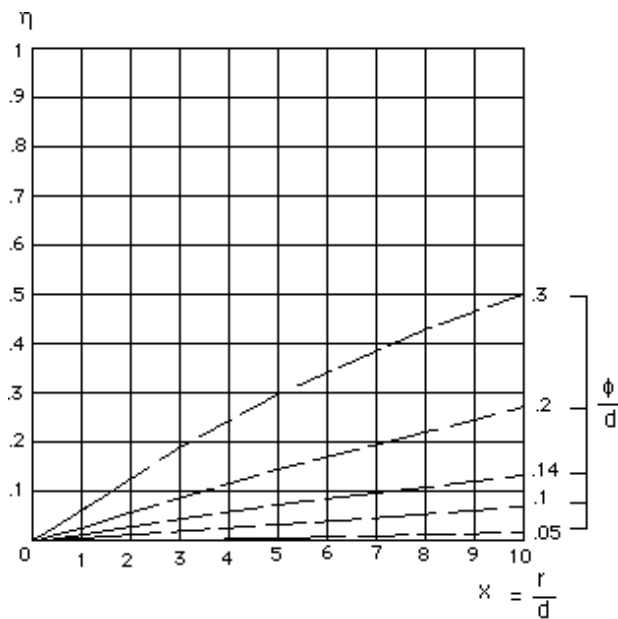

Fig. 3: probability to observe anti-lensing (negative lensing) effect versus distance, for different values of Φ/d

The computational results, presented in the paper, correspond to the value $\Phi/d \approx 0.14$. But dissipative processes may occur in the clumps, that could drastically reduce their diameter, transforming these objects. The today's averaged ratio (twin matter density / normal matter density) $|\rho|/\rho$ is 64. If clumps transform into relatively small objects we could expect to get unaltered images from distant sources (quasars, galaxies). A cluster of galaxies, roughly speaking, acts as a biconvex lens. A twin matter clump would act as a concave lens. The images of distant galaxies, through such gravitational

lens, should appear smaller, fainter and more numerous as pointed out by Peebles (ref. [12], page 311).

4- A possible schema for galaxies' formation.

When the cells form, the two populations separate. The twin matter clumps repel and compress the ordinary matter, forming the cell's walls. In these walls the temperature grows and this peculiar geometric configuration is optimum for fast radiative energy dissipation. The subsequent decrease of temperature in the gas of the walls makes them gravitationally unstable, and proto galaxies form. In the same time twin matter takes place in the inter-galactic space and exert a counter-pressure on them, which ensures their confinement.

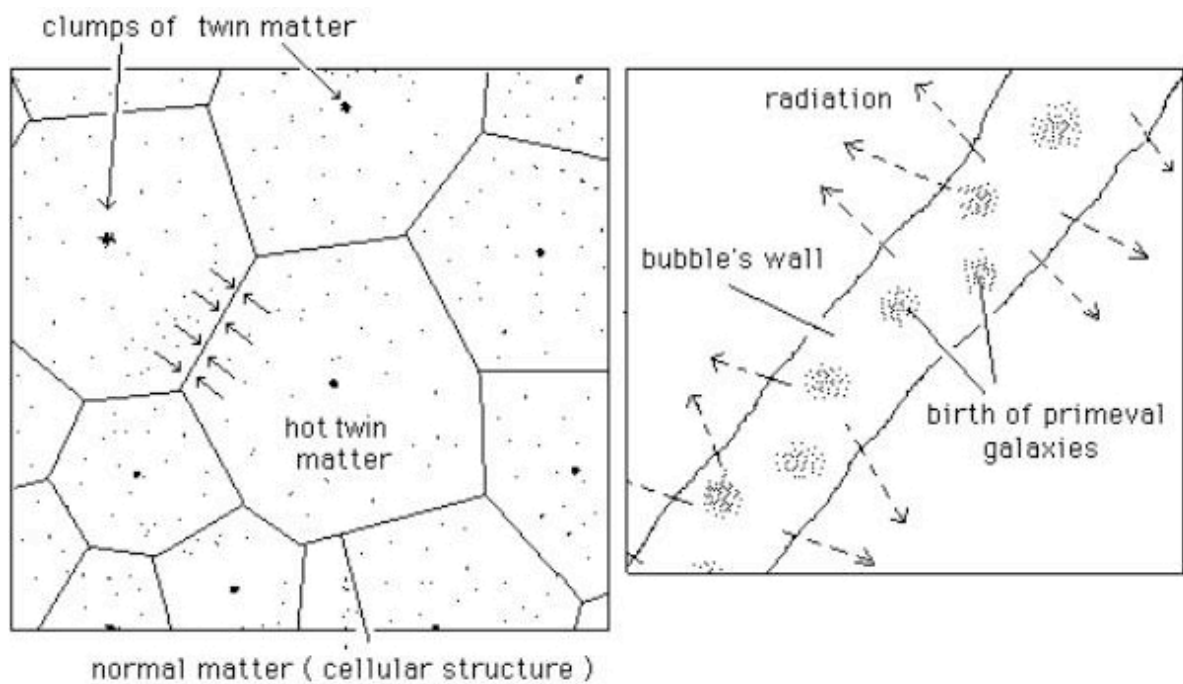

Fig. 4: A possible schema for galaxies' formation. Left, matter is compressed by repulsive effect of twin matter's clumps, located at the centre of the cells. Right: fast radiative cooling of this matter which becomes unstable and forms young galaxies.

As we see this model brings new insights of astrophysical problems and deserves 3d computations. Let us look more closely to the question of the confinement of galaxies.

5- Galaxies confined by surrounding twin matter counter-pressure.

Everybody knows that no self-consistent model of a galaxy exists. Their description remains purely empirical. The galactic dynamics is a complete mystery. Today, theoreticians spray ad hoc distributions of unidentified dark matter, in order to fit gas rotation curves, that's all. Let's try to modelize this through the interaction of matter and surrounding twin matter. We start from the galaxy's density profile as given by Myamoto and Nagai [13]:

$$\rho_z(r, z) = \frac{b^2 M}{4 \xi} \frac{a r^2 + (a + 3 \sqrt{z^2 + b^2}) (a + \sqrt{z^2 + b^2})^2}{[r^2 + (a + \sqrt{z^2 + b^2})^2]^{5/2} (z^2 + b^2)^{3/2}}$$

Around, we install a succession of elliptic twin matter shells, owing same eccentricity, whose density grows from the centre to infinite (see their density profile, figure 5, below). The Newtonian field created by such thick shell is given by simple analytic formula [14]. Now we add the galaxy, which reinforces the gravitational field, mainly close to the centre, where the pressure force balances the field. As shown on figure 3 the gravitational force has a confining z-component. Such a phenomenon might explain the anomalous large z-velocities, evidenced by Bahcall ([16] and [17]) for K stars. A complete and systematic study should be carried out by this method. Finding these large velocities, Bahcall concludes that some dark matter must be present in the disk of the galaxies. According to our model, that could be due to the repulsive effect of:

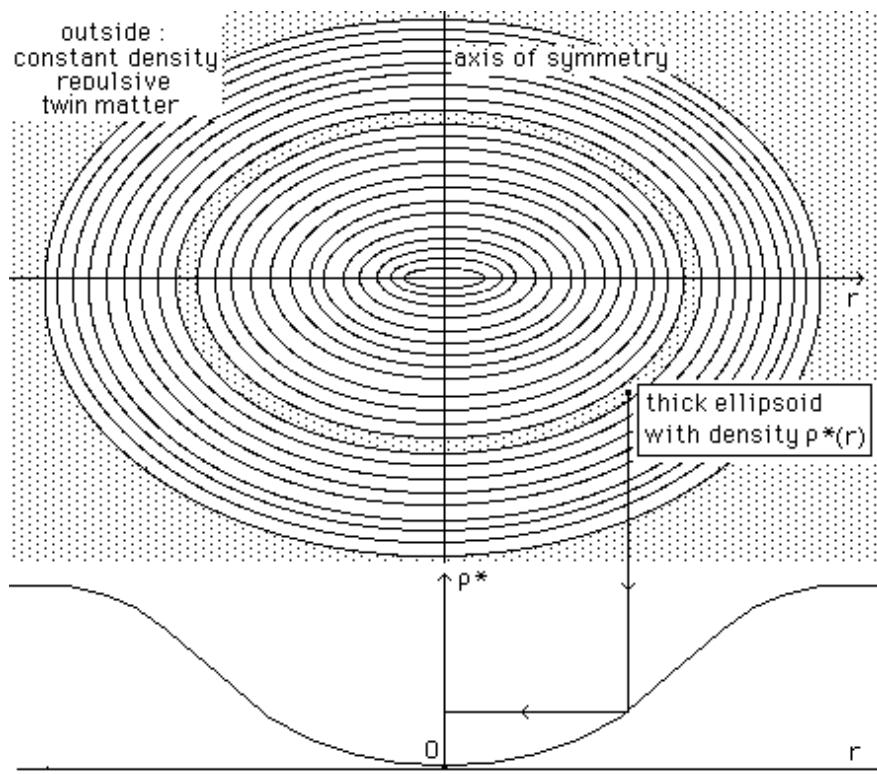

**Fig. 5: Ad hoc twin matter distribution, for 3d confinement.
The density is constant between successive homothetic flat ellipsoids.**

surrounding repulsive dark matter: an alternative interpretation. In general, starting from observational data, people can compute the distribution $\rho_{dm}(r,z)$ of "conventional" dark matter in space. Similarly, from same observational data, it is possible to build a corresponding distribution $\underline{\rho}(r,z)$ of repulsive repulsive dark matter, through the method presented above. The local intensity of the gravitational field depends on the chosen distribution. Here we have used a system of concentric shells figured as a set of thick ellipsoids with the same eccentricities (but eccentricities might be different: any kind of distribution $\underline{\rho}(r,z)$ of repulsive repulsive dark matter can be managed by this method). We get a rotation curve, corresponding to gas orbiting in the $z = 0$ plane, good-looking, as shown on figure 7. The scale, shown, corresponds to figure 8.

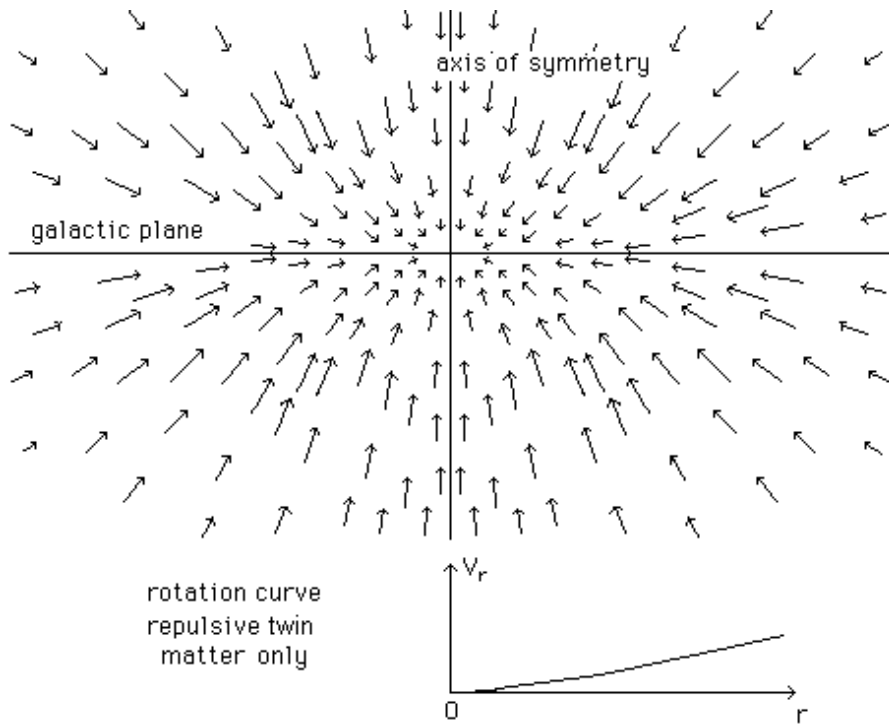

Fig. 6: Confining field and corresponding rotation curve (circular velocity of $m = +1$ test-particle)

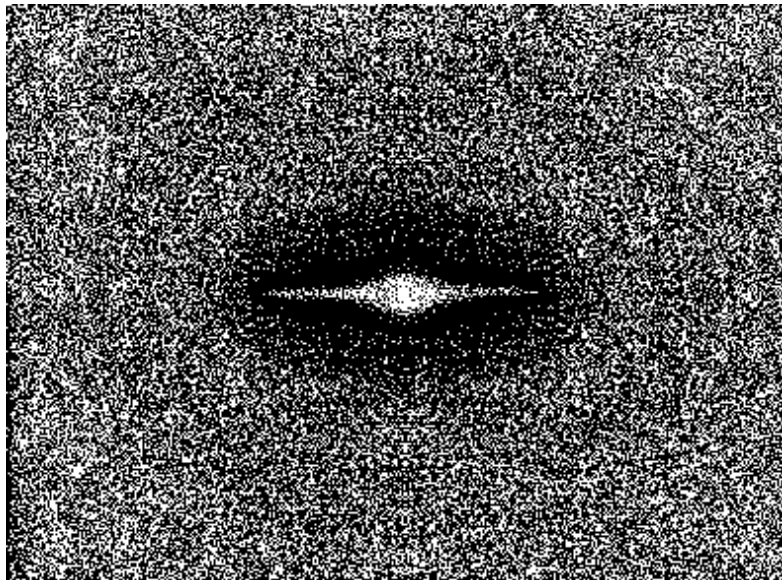

Fig. 7: The galaxy, plus its environment of hot twin matter.

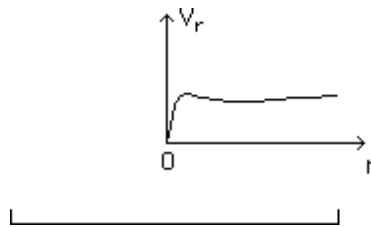

Fig. 8: Combining the two fields we get a good-looking galactic rotation curve.

The repulsive dark matter environment acts as a "box". The flatter that box, the stronger the corresponding impact on the z-confinement effect is. With the chosen parameters, the z-confinement enlarges the velocity of the stars located at $z = 0.2 d_g$ (where d_g is the overall diameter of the galaxy) by a factor 1.4. By the way, the presence of repulsive material at the vicinity of the galaxy explains the steep fall of the density at the periphery of the gas disk. The global gravitational field (acting on the repulsive dark matter) tends to enlarge the hole. But its pressure gradient balances it: if the galaxy was removed, the repulsive dark matter fills the hole. The repulsive dark matter distribution was shaped on empirical grounds, through numerous trials and various sets of massive ellipsoids. It could be a starting point for full 3d numerical simulations, which are beyond our today's computational possibilities. Moreover, we believe that a more elegant model could be built, using Vlasov equations, coupled with Poisson equation. By the way, are spheroidal galaxies confined in the same way, nested in spheroidal holes managed in constant density twin matter? Isin't contradictory the the Gauss theorem which would tend to give a zero Newtonian field inside the hole? To get the answer, go to section 18.

6- Spiral structure.

Since many years astrophysicists try to understand what produces the spiral patterns of the galaxies, and if it is a transient phenomenon or not. In 1959 Lindblad [18] suggested that the spiral arms could be density waves. Later Lin and Shu regarded the spiral pattern as a wave pattern [19]. Their analysis, based on the set of the equations of Vlasov and Poisson, used a perturbation method, which could not provide non-linear patterns, so that they imagined that some spiral perturbation could appear in the star population and trigger the gas, whose strongly non-linear response could explain the observed Grand Design. Toomree gave later theoretical arguments supporting this idea [20]. At the beginning of the seventies, Toomree explored another interpretation of the spiral origin: the action of a companion [21]. This was extended later ([22] and [23]). In effect, some of the nicest examples of global spiral structures have close companions, like the well-known M51 [24], but not all the galaxies with global spiral structure have a close companion. Typically, a galaxy is composed by 10^{11} stars. In numerical simulations, one deals with 10^4 to 10^6 interacting objects, considered as self-gravitating groups of stars. Most of the simulations tried so far were 2d, and neglected z-motions. Some fully calculations have been attempted [25]. A number of early simulations verified that isolated disks could be axisymmetrically unstable: a bar forms in the early stage of the evolution and, with relatively small change of amplitude, shape and pattern speed, and survives the end of the calculation. But, if spiral pattern appears, it tends to disappear quite rapidly. Transient spiral structures appears in the initial stage of each run but, unless the bar instability has been suppressed, it heats the disk to temperatures suffocating the spirals [26]. The sweedish school has been pioneer in the study of interacting galaxies device [27]. See also reference [28]. But all the spiral galaxies are not interacting galaxies, so that the problem remains unsolved. In other works, based on numerical

simulations, people studied "impulsively perturbed galaxies", omitting to describe the origin of the perturbation [29]. As a conclusion we still do not have a convincing model explaining why many galaxies have a spiral structure, barred or not, and if it is or not a transient phenomenon. Through analytic methods or numerical simulations many people suggested different mechanisms, evoked. Some think now that the solution requires a better knowledge of the physics of the galaxy, including dissipative process. Such process could cool the material of the spiral arms and prevent their dissipation, but the problem is to justify how these dissipative processes occur. In 1972 Toomre wrote [30]: "Happily it remains a subject where it makes sense to start almost at the beginning". That is what we are going to do. This work was initiated by Frederic Landsheat at the beginning of the nineties, through 2d simulations. To deal with border conditions, we used a classical periodical lattice. With such method (see discussion about spatially periodic systems in F.Bouchet and L.Hernquist, reference [31] and F.Bouchet, L.Hernquist and Y.Suto, reference [32]) we obtained in 1992 good looking films showing the birth of a barred spiral (figure 9) with 2×5000 mass-points. The twin structure is not shown. As for VLS, the good surprise was the remarkable stability of the Grand Design, over 50 turns. Same explanation: the surrounding repellent twin matter forms a potential barrier which prevents spiral arms dissipation. On figure 9 the evolution of the momentum of the galaxy, versus the number of turns. When the grand design forms, the strong observed slowing down is due to dynamical friction. Then, after few turns, tidal effects dominate.

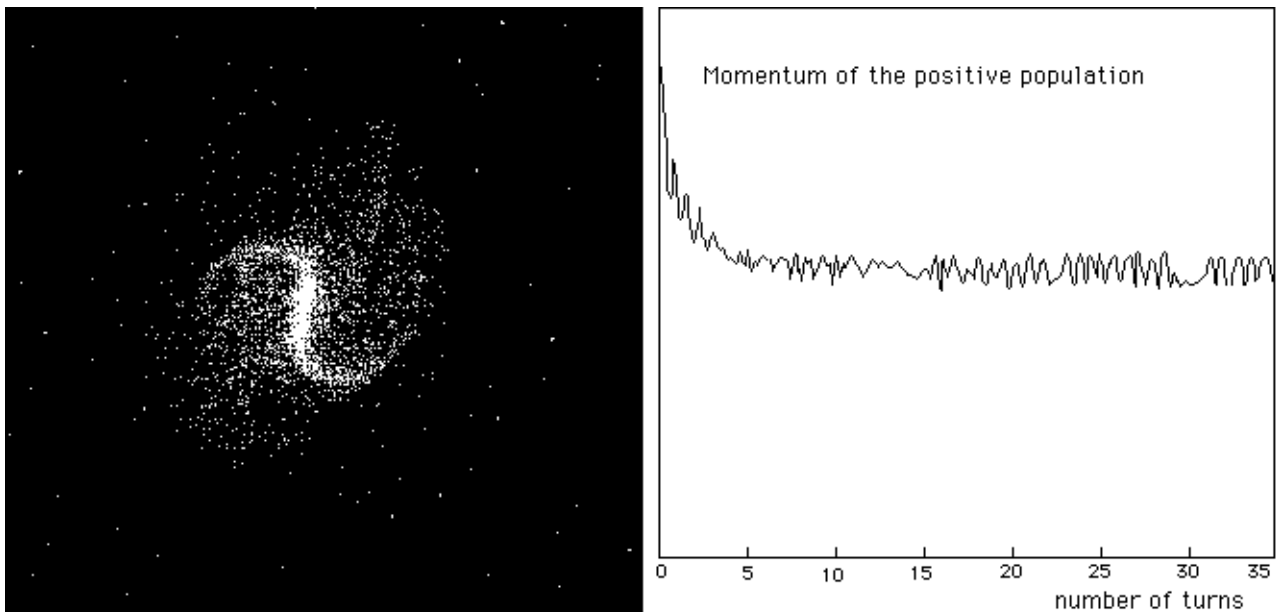

Fig. 9: Barred spiral (J.P.Petit & F.Landsheat, 1993)

These images were encouraging, but the work was stopped because Landsheat, who worked at DAISY, Germany, had to join a new lab where he could not use an adequate computational system.

7- Gravitational lensing due to negative mass matter.

In classical general relativity the (steady) geometry of space-time, in and around a sphere filled by constant density matter, and surrounded by void is described by two joined metrics. The first is the "internal Schwarzschild metric":

$$ds^2 = \left[\frac{3}{2} \sqrt{1 - \frac{r_0^2}{\hat{R}^2}} - \frac{1}{2} \sqrt{1 - \frac{r^2}{\hat{R}^2}} \right]^2 c^2 dt^2 - \frac{dr^2}{1 - \frac{r^2}{\hat{R}^2}} - r^2 (d\theta^2 + \sin^2\theta d\phi^2) \text{ for } r \leq r_0 \quad \hat{R}^2 = \frac{3c^2}{8\pi G\rho}$$

with the condition:

$$r \ll \hat{R} \quad r_0 \ll \hat{R}$$

and the second the "external Schwarzschild metric":

$$ds^2 = \left(1 - \frac{R_s}{r_0}\right) c^2 dt^2 - \frac{dr^2}{1 - \frac{R_s}{r_0}} - r_0^2 (d\theta^2 + \sin^2\theta d\phi^2) \quad (R_s = 2m)$$

Classical gravitational lensing is computed with the second, where m, a simple integration constant, is chosen positive. Then the plane trajectory of a massive particle is given by

$$\varphi(u) = \varphi_0 + \int_{u_0}^u \frac{du}{\sqrt{\frac{c^2 b^2 - 1}{h^2} + \frac{R_s}{h^2} u - u^2 + R_s u^3}}$$

where φ is the polar angle, and u the inverse of radial distance r , with respect to the geometric centre of the system. The photons obey:

$$\varphi(u) = \varphi_0 + \int_{u_0}^u \frac{du}{\sqrt{\frac{c^2 b^2}{h^2} - u^2 + R_s u^3}}$$

where c is the light velocity, h and l paths parameters. This gives the classical schema of figure 10-a where the central mass is reduced to a simple mass-point. Now, have a look to (16) and (18). We can change ρ into $-\rho$ and R_s into $-R_s$. Then we get the:

(16bis)

$$ds^{*2} = \frac{B}{\sqrt{1 + \frac{r^2}{\hat{R}^2}}} c^2 dt^2 - \frac{dr^2}{1 + \frac{r^2}{\hat{R}^2}} - r^2 (d\theta^2 + \sin^2\theta d\phi^2) \text{ for } r \leq r_0 \quad \hat{R}^2 = \frac{3c^2}{8\pi G\rho}$$

$$ds^2 = \left(1 + \frac{R_s}{r_0}\right) c^2 dt^2 - \frac{dr^2}{1 + \frac{R_s}{r_0}} - r_0^2 (d\theta^2 + \sin^2\theta d\phi^2)$$

These solution can be linked and describe the geometry in and out a sphere filled by negative mass.

The first is solution of $\mathbf{S} = \chi \mathbf{T}$. The second comes from $\mathbf{S} = 0$. As introduced in 1995 in reference [3] we get a negative lensing effect. See figure 10-b:

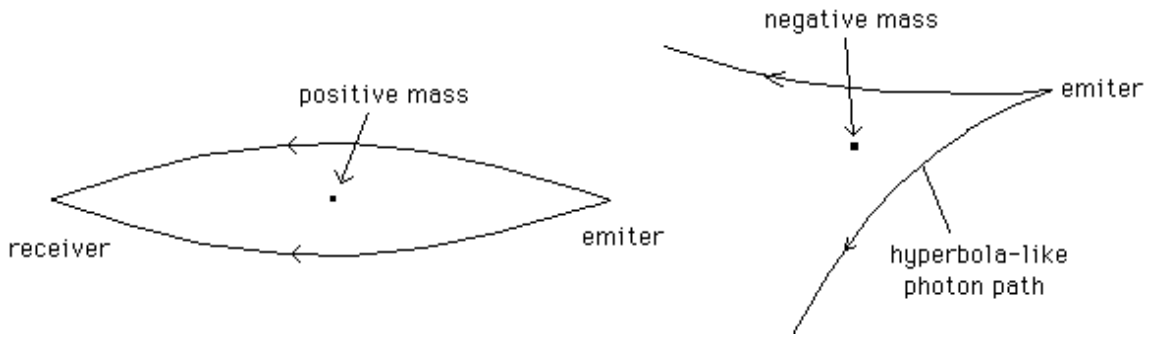

Fig. 10-a: Positive gravitational lensing effect

Fig.10-b: Negative gravitational lensing effect

Notice we may now use the internal solution for photons can cross a negative mass clump, according to our assumption (like neutrinos can cross the sun. But we have no telescopes using neutrinos). Now, examine the impact on observations. The first one is the reduction of the luminosity of large redshift galaxies, by negative gravitational lensing effect due to twin matter clumps. As the matterfact, we find many faint galaxies at large distance. The classical interpretation consists to say that dwarfs galaxies form first, then merge to give heavier objetscs. Negative lensing provides an alternative explanation. Now, let us show that negative lensing, due to surrounding twin matter, can explain observed strong lensing effects, around galaxies and clusters of galaxies. First, notice than any homogeneous distribution of matter, with positive or negative density, does not induce gravitational lensing. Only non-homogeneous distribution dot it. Let us figure schematically a galaxy imbedded in some sort of hole in an homogeneous twin matter distribution. See fig. 11-a:

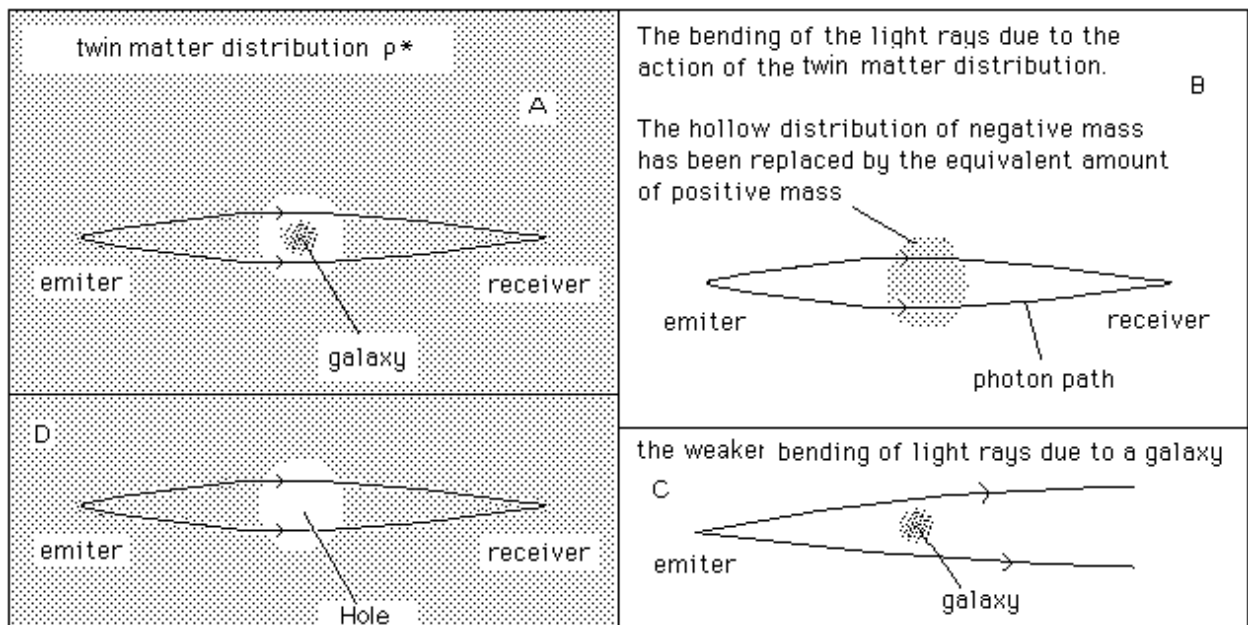

Fig. 11: Combination of positive (due to the confined object) and negative (due to the surrounding twin matter) lensing effects. Reinforcement of the global effect.

We have schematised the reinforcement of the gravitational effect due to twin matter surrounding a

spheroidal mass M (spheroidal galaxy or spheroidal cluster of galaxies). As shown in section 18 the gravitational field due to a spheroidal hole in a constant density negative mass distribution is equivalent to the field due to a constant density sphere, filled by positive mass (figure 11-b). On figure 11-c we have figured the contribution of the positive mass M to the gravitational lensing effect. The main effect (figure 11-c) is due to the hole, which focuses the light rays. On figure 11-a we find the two effects, combined. As a conclusion the observation of strong gravitational lensing effects at the vicinity of galaxies or clusters of galaxies is not the final proof that some positive mass invisible dark matter is present. There is an alternative interpretation: the object could be surrounded by negative matter, which focusses the light rays.

8- Exotic matter or exotic geometry?

As said above, physicists have difficulty to stand the idea that negative mass could exist in our universe. By the way, the classical standard model does not bring all the answers. For example, nobody knows where the primeval antimatter is gone, so that half part of the universe is missing. The question became so embarrassing that today scientists just choose to avoid it. In 1967 A.Sakharov suggested that some "twin universe" would have been created during the so-called Big Bang, where the arrow of time could be reversed ([33],[34],[35]&[36]). The idea of a couple of universes interacting only through gravitational force is in progress, see a recent paper of Nima-Arkani Ahmed (Dept. of Phys. of Berkeley U.), Savas Domopoulos (Dept. of Phys of Stanford U.) and Georgi Dvali (Dept. of Phys. Of new-York Univ.), reference [43] and references [37] to [42] .

Assume the universe is the two-folds cover of a M_4 manifold.

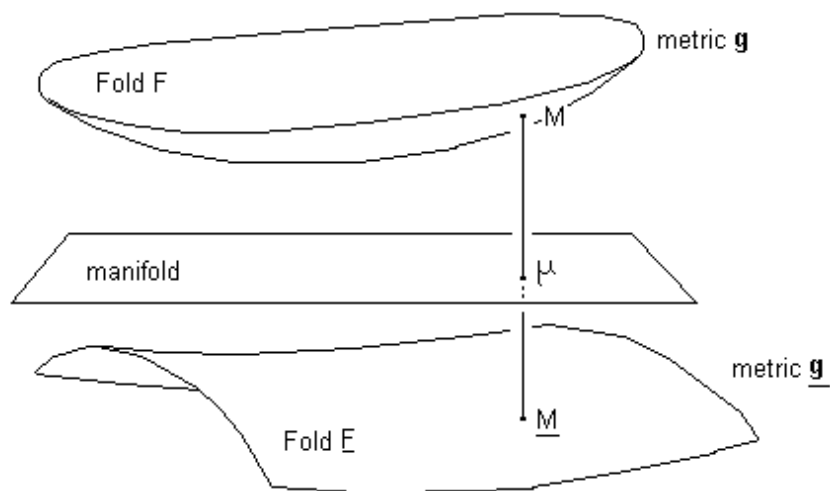

Fig.12: Two folds cover of a manifold.

We get a point-to-point mapping, linking two "conjugated points" M and \underline{M} , which can be described by a same system of coordinates $\{\mu_i\}$ We can give this non simply connected two-folds cover a metric structure (similar to the two-points bundle of a manifold M_4). Call F and \underline{E} its two folds. Give the fold F a Riemanian metric \underline{g} with $(+ - - -)$ signature. Call \underline{g} the Riemanian metric with same signature, associated to fold \underline{E} . From these two metrics we can build geodesics systems but, as F and \underline{E} and disconnected, the two families of geodesics are disconnected. As a conclusion, if these metrics give null-geodesics and if one assume that light travels along them in both folds, any

structure of a given fold will be geometrically invisible from the other one. In classical General Relativity one considers a single fold, associated to the Einstein field equation:

$$\mathbf{S} = \chi \mathbf{T} - \Lambda \mathbf{g}$$

where \mathbf{S} is a geometrical tensor, χ is the Einstein constant, \mathbf{T} is the energy-matter tensor and Λ the so-called, puzzling cosmological constant, introduced by the French mathematician Elie Cartan.

During a long time theoreticians used to assume that this last was zero. Then, non-steady solutions, corresponding to homogeneous and isotropic conditions give the Friedman models. Steady-state solutions, while spherical symmetry gives the internal Schwarzschild solution (16), from the equation $\mathbf{S} = \chi \mathbf{T}$ where \mathbf{T} is a constant tensor field, inside a sphere whose radius is r_0 . The external Schwarzschild solution (18) comes from $\mathbf{S} = 0$ with spherical symmetry too. The choice of a field equation is an a priori choice. If metric solutions are asymptotically flat, Lorentzian, it ensures the validity of Special relativity in vacuum. If one makes an expansion into a series around a Lorentz metric, in steady state conditions, the field equation can be identified to Poisson equation $\Delta \psi = 4 \pi G \rho$ where ψ is the gravitational. In addition, the Newtonian approximation provides the Newton law of interaction. Friedman models, corresponding to solutions of the field equation, provide a redshift, which is observed. Locally, the bending of light rays at the vicinity of the sun as well as the precession of Mercury's perihelion are observed too. But recently some discrepancy between Friedman models and Hubble's constant measurements lead today the cosmologists to reintroduce a non-zero cosmological constant, corresponding to some mysterious "repulsive power of vacuum". Now, return to the two-folds structure. Introduce two tensor fields \mathbf{T} and $\underline{\mathbf{T}}$ which are supposed to describe the contents of folds F and \underline{F} . From metrics \mathbf{g} and $\underline{\mathbf{g}}$ we can define derive geometric tensors \mathbf{S} and $\underline{\mathbf{S}}$. We can link the four tensors \mathbf{S} , $\underline{\mathbf{S}}$, \mathbf{T} , $\underline{\mathbf{T}}$ into a system of two coupled field equations, inspired by Einstein equation

9- First geometrical interpretation of the dark matter phenomenon.

Consider the following coupled field equations:

$$\mathbf{S} = \chi (\mathbf{T} + \underline{\mathbf{T}}) \qquad \underline{\mathbf{S}} = \chi (\mathbf{T} + \underline{\mathbf{T}})$$

Basically, they are identical, so that \mathbf{g} identifies to $\underline{\mathbf{g}}$: the image of a geodesic of fold F becomes a geodesic of fold \underline{F} . We get two "parallel" universes, which interact only through gravitational force. Dark matter can be composed by atoms, neutrons, protons, photons, identical to ours, except we cannot observe twin matter on geometrical grounds. If we study the Newtonian approximation, we get the following Poisson equation: $\Delta \psi = 4 \pi G (\rho + \underline{\rho})$

In this model:

- matter attracts matter
- twin matter attracts twin matter
- matter and twin matter attract each other.

But this does not solve all the observational data: even if some geometrically invisible dark matter would lie in the adjacent portion of our universe, near by the Abell 1942 cluster, this does not explain why this attractive force field would not capture our own galaxies and gas, lying in our fold of the universe. That's for we deal with the following set of equations (reference [3] and [4]):

10- Second geometrical interpretation of the dark matter phenomenon.

Consider the following coupled field equations system:

$$\mathbf{S} = \chi (\mathbf{T} - \underline{\mathbf{T}}) \quad \underline{\mathbf{S}} = \chi (\underline{\mathbf{T}} - \mathbf{T}) \quad \text{from which } \underline{\mathbf{S}} = -\mathbf{S}$$

Notice this definitively not imply $\mathbf{g} = -\mathbf{g}$. The Newtonian approximation supports the assumptions of section 3. We get the following Poisson equation:

$$\Delta \psi = 4 \pi G (\text{matter density in fold F} - \underline{\text{matter density in fold F}})$$

We prefer to consider that the twin universe, the twin fold, is filled by intrinsically positive mass matter and that the minus sign in the field equation gives it the appearance of a negative mass for an observer located in our fold. Then we may call it "apparent mass". The symmetry of system (29) plus (30) makes the definition of positive and negative energies purely arbitrary. What about the classical local check of the RG? In this new model:

- matter attracts matter, through Newton law.
- twin matter attracts twin matter through Newton law.
- matter and twin matter repel each other through an "anti-Newton law".

The solar system is a very dense portion of the universe. In the adjacent portion of the twin fold, twin matter is pushed away. Then the system is very close to:

$$\mathbf{S} = \chi \mathbf{T} \quad \underline{\mathbf{S}} = -\mathbf{T}$$

The first equation identifies to Einstein equation, so that all the classical verifications fit. . What about gravitons? Which path do they follow? The answer is composed by two arguments :

- Field equations provide macroscopic description of the universe, which ignores the existence of particles and just gives geodesic systems.
- By the way: what's a graviton?

Notice that recently [49], anomalous long-range (negative) acceleration has been evidenced for space probes Pioneer 10 and Pioneer 11, at long distance from the sun (40-60 AU). An unmodelled acceleration, directed *towards* the Sun, $(8.09 \pm 0.20) \times 10^{-8} \text{ cm/s}^2$ for Pioneer 10 and $(8.56 \pm 0.15) \times 10^{-8} \text{ cm/s}^2$ for Pioneer 11, was evidenced and described as a *not-understood viscous drag force*. Similarly, and unmodelled acceleration towards the sun was found for the probe Ulysse $(12 \pm 3) \times 10^{-8} \text{ cm/s}^2$. See complete discussion in this interesting paper. The authors say: *The paradigm is obvious: is it dark matter or modification of gravity*". As the pointed out, if dark matter is called for explanation, it would correspond to a total dark matter amount $> 3 \times 10^4$ solar mass, which would be in conflict with the accuracy of the ephemeris. A 3d neutrino model also did not solve the problem [50]. Others try to modify the Newton law, adding a Yukawa force [51]. But *"this anomalous acceleration is too large to have gone undetected in planetary orbits, particularly for Earth and Mars"*. Then they focus on available Viking probes data and conclude: *"But a large error would cause inconsistency with the overall planetary ephemeris.... if the anomalous radial acceleration acting on spinning spacecraft is gravitational in origin, it is not universal. That is, it*

must affect bodies in the 1000 kg range more than bodies of planetary size by a factor 100 or more (...), which would be a strange violation of the equivalence principle". An alternative interpretation of this still puzzling phenomenon would be the action of weak repulsive twin matter distribution between stars, inside galaxies, which would form, as for spiral structure, a weak potential barrier. To be investigated.

11- The question of the repulsive power of vacuum. An alternative answer.

When we look to equation (29) we see that \underline{T} acts like a "cosmological constant". It figures the "repulsive power of the twin universe", which can play a role in non-steady coupled solutions. Assumption of homogeneity and isotropy gives the Riemannian metrics the well-known Robertson-Walker form, as follows:

$$ds^2 = c^2 dt^2 - \frac{R^2}{\left(1 + \frac{k u^2}{4}\right)^2} (du^2 + u^2 d\theta^2 + u^2 \sin^2\theta d\varphi^2)$$

$$d\underline{s}^2 = \underline{c}^2 d\underline{t}^2 - \frac{\underline{R}^2}{\left(1 + \frac{\underline{k} \underline{u}^2}{4}\right)^2} (d\underline{u}^2 + \underline{u}^2 d\underline{\theta}^2 + \underline{u}^2 \sin^2\underline{\theta} d\underline{\varphi}^2)$$

The radial distances between conjugated points (same u , an non-dimensional "radial distance", with respect to an arbitrary point) are not automatically equal:

$$r = R u \quad \underline{r} = \underline{R} \underline{u}$$

Write non-dimensional coordinates, where τ is the time-marker.

$$\{\tau, u, \theta, \varphi\}$$

$\{u, \theta, \varphi\}$ are classical spherical coordinates. Remember that a field equation is coordinate-invariant. The choice of coordinates remains free, in each fold, where we can define different cosmic times:

$$.t \quad \text{and} \quad \underline{t}$$

These variables are linked to the non-dimensional variable τ through:

$$t = T \tau \quad \underline{t} = \underline{T} \tau$$

where T and \underline{T} are characteristic times scales. Introducing non-dimensional proper times σ and $\underline{\sigma}$:

$$s = cT \sigma \quad \underline{s} = -\underline{c} \underline{T} \underline{\sigma}$$

we transform the two metrics into their non-dimensional forms, introducing non-dimensional scale factors $R(\tau)$ and $\underline{R}(\tau)$, through:

$$R = cT R \quad \underline{R} = \underline{c} \underline{T} \underline{R}$$

$$d\sigma^2 = dt^2 - \frac{R^3}{(1 + \frac{k}{4} u^2)^2} d\eta^2 \quad d\underline{\sigma}^2 = dt^2 - \frac{\underline{R}^3}{(1 + \frac{\underline{k}}{4} \underline{u}^2)^2} d\underline{\eta}^2$$

We put the field equations into their non-dimensional forms, using:

$$\rho = \rho_0 \omega \quad \underline{\rho} = \underline{\rho}_0 \underline{\omega} \quad p = p_0 \pi \quad \underline{p} = \underline{p}_0 \underline{\pi}$$

Following, these tensors, written in their non-dimensional forms:

$$\boldsymbol{\tau} = \begin{vmatrix} \omega & 0 & 0 & 0 \\ 0 & -\pi & 0 & 0 \\ 0 & 0 & -\pi & 0 \\ 0 & 0 & 0 & -\pi \end{vmatrix} \quad \underline{\boldsymbol{\tau}} = \begin{vmatrix} \underline{\omega} & 0 & 0 & 0 \\ 0 & -\underline{\pi} & 0 & 0 \\ 0 & 0 & -\underline{\pi} & 0 \\ 0 & 0 & 0 & -\underline{\pi} \end{vmatrix}$$

At the end, we get four second order coupled differential equations (instead two, in the classical approach):

$\frac{2R''}{R} + \frac{R'^2}{R^2} + \frac{k c^2}{R^2} = -8\pi G (\pi - \underline{\pi})$	$\frac{2\underline{R}''}{\underline{R}} + \frac{\underline{R}'^2}{\underline{R}^2} + \frac{\underline{k} c^2}{\underline{R}^2} = -8\pi G (\underline{\pi} - \pi)$
$\frac{R'^2}{2} + \frac{k c^2}{R^2} = \frac{8\pi G}{3} (\omega - \underline{\omega})$	$\frac{\underline{R}'^2}{2} + \frac{\underline{k} c^2}{\underline{R}^2} = \frac{8\pi G}{3} (\underline{\omega} - \omega)$

We need some additional hypothesis. Assume that the two universes have "parallel lives" during their radiative epoch, i.e: $\omega(\tau) = \omega^*(\tau)$, which impose negative curvature indexes ($k = \underline{k} = -1$). After decoupling we neglect the pressure terms (dust universes):

$\frac{2R''}{R} + \frac{R'^2}{R^2} + \frac{k}{R^2} = 0$	$\frac{2\underline{R}''}{\underline{R}} + \frac{\underline{R}'^2}{\underline{R}^2} + \frac{\underline{k}}{\underline{R}^2} = 0$
$\frac{R'^2}{R^2} + \frac{k}{R^2} = 0$	$\frac{\underline{R}'^2}{\underline{R}^2} + \frac{\underline{k}}{\underline{R}^2} = 0$

from which we get immediately:

$$\frac{2R''}{R} = -\frac{8\pi G}{3} (\omega - \underline{\omega}) \quad \frac{2\underline{R}''}{\underline{R}} = -\frac{8\pi G}{3} (\underline{\omega} - \omega)$$

Introducing the mass-conservation in both folds:

$$\omega R^3 = \text{constant} \quad \underline{\omega} \underline{R}^3 = \text{constant}$$

the system becomes:

$$R^2 R'' + 1 - \frac{R^3}{R^3} = 0 \quad \underline{R}^2 \underline{R}'' + 1 - \frac{\underline{R}^3}{\underline{R}^3} = 0$$

Notice that $R = \underline{R}$ gives $R'' = \underline{R}'' = 0$. On another hand, if the two universes were "fully coupled", i.e. $\underline{R}/R = \text{constant}$, this peculiar solution would correspond to Friedmann models, with "parallel

evolutions". But we consider that they are coupled by gravitational field, through (54-a) and (54-b), which shows that the linear expansion is unstable. If, for an example, if $R > \underline{R}$ then $R'' > 0$ and $\underline{R}'' < 0$. The system can be numerically solved. The typical solution corresponds to figure 13. The numerical values have been chosen in order to fit the initial condition for VLS numerical simulation. The law of evolution, for the radiative epoch will be justified in section 15.

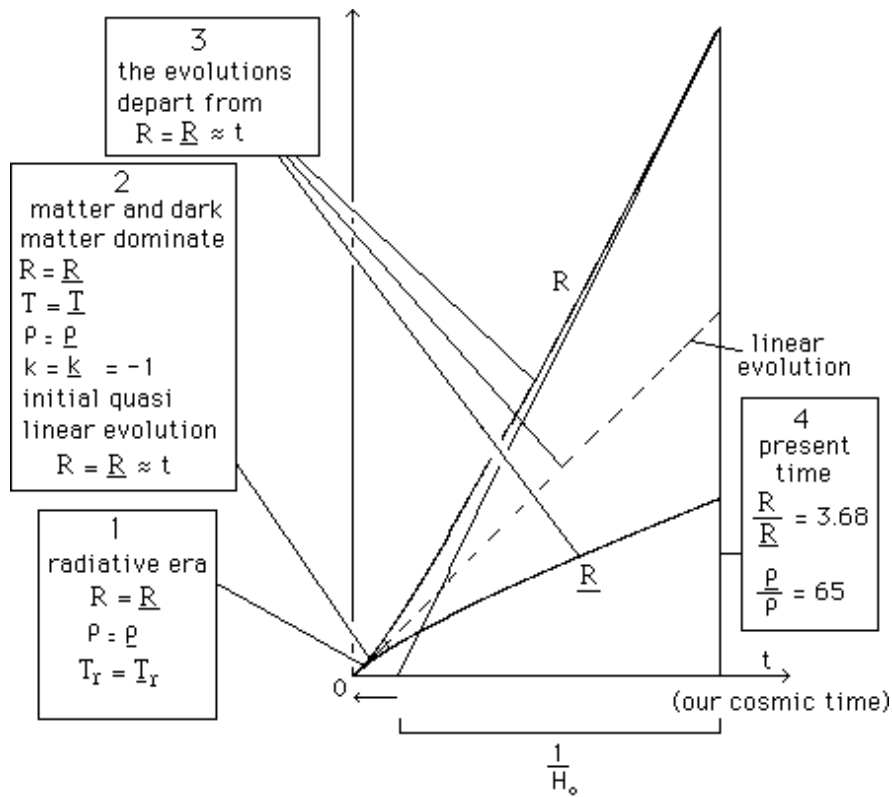

Fig.13: The evolution of the scale parameters of the universe and twin universe.

We see that this system of two universes interacting through gravitational force is unstable. If one universe goes faster, pushed by his twin, the other one slows down. The observed acceleration of our universe is then caused by the "repulsive power of its twin universe". The histories of the two differ. Ours is cooler and more rarefied. The twin is warmer and denser. This justifies the assumption of section 2, which determines the VLS.

What could be the evolution of our twin universe? As we have seen, it is filled by huge clumps of twin matter which look like huge proto-stars, whose cooling time is fairly larger than the age of the universe. Fusion does not occur in the twin universe. We think after first nucleo-synthesis, it remains filled by hydrogen and helium. Life phenomenon would not exist in the twin universe.

12- Newton's law and Poisson equation.

In classical General Relativity the Newton law and the Poisson equation can be derived from Einstein field equation, considering an almost steady state and almost Lorentzian metric solution. Here, we have two perturbed metrics, written in non-dimensional coordinates $\omega^*(\text{time})$, $\zeta^\alpha(\text{space})$

$$d\sigma^2 = d\tau^2 - d\eta^2 + \gamma_{\mu\nu} d\zeta^\mu d\zeta^\nu \qquad d\sigma^{*2} = d\tau^2 - d\eta^2 + \gamma^*_{\mu\nu} d\zeta^\mu d\zeta^\nu$$

Expanding the two field equations into series, and considering an almost uniform universe we get

$$-\sum_{i=1}^3 \gamma_{00i} l_i = -8 \pi (\omega - \underline{\omega}) \qquad -\sum_{i=1}^3 \underline{\gamma}_{00i} l_i = -8 \pi (\underline{\omega} - \omega)$$

Introduce a non-dimensional gravitational potential:

$$\Xi = \frac{1}{2} \gamma_{00}$$

Defining a non-dimensional Laplacian operator:

$$\Delta_{\zeta} = \frac{\partial^2}{\partial \zeta^1{}^2} + \frac{\partial^2}{\partial \zeta^2{}^2} + \frac{\partial^2}{\partial \zeta^3{}^2}$$

we get a non-dimensional Poisson equation:

$$\Delta_{\zeta} \Xi = 4 \pi (\omega - \underline{\omega})$$

The classical method of identification gives the Newton law. In fold F:

$$\frac{d^2 \zeta^\alpha}{d\tau^2} = - \frac{\partial \Xi}{\partial \zeta^\alpha}$$

In fold \underline{F} :

$$\frac{d^2 \zeta^\alpha}{d\tau^2} = \frac{\partial \Xi}{\partial \zeta^\alpha}$$

The gravitational potential acts differently on a ($m = +1$) test-particle. Depends the fold it belongs to. In general a ($m = +1$) particle located in fold F gives the following contribution the the (non-dimensional) gravitational potential.

$$\frac{d^2 \zeta}{d\tau^2} = - \frac{\mathbf{u}}{u^3}$$

As we can see, the system of coupled field equations determines completely the dynamics of the system, corresponding to Newtonian approximation, as introduced as an hypothesis in the beginning of the paper. In the model the velocities of light c and \underline{c} may be different (and we think they are). Using the dimensional quantities introduced in section 11 we may return to dimensional laws, as following:

$$\frac{d^2 \mathbf{x}^\alpha}{dt^2} = -c^2 \frac{\partial \Xi}{\partial \mathbf{x}^\alpha} \qquad \frac{d^2 \underline{\mathbf{x}}^\alpha}{d\underline{t}^2} = \underline{c}^2 \frac{\partial \Xi}{\partial \underline{\mathbf{x}}^\alpha}$$

$$\Psi = c^2 \Xi \qquad \underline{\Psi} = - \frac{\underline{c}^2}{c^2} \Psi$$

The Newton law, expressed in the two folds, becomes:

$$\frac{d^2 \mathbf{r}}{dt^2} = - \frac{\partial \Psi}{\partial \mathbf{r}} \qquad \frac{d^2 \underline{\mathbf{r}}}{d\underline{t}^2} = - \frac{\partial \underline{\Psi}}{\partial \underline{\mathbf{r}}}$$

The Poisson equation can be expressed indifferently in both folds

$$\Delta \psi = 4 \pi G (\rho - \underline{\rho})$$

13- Scalar curvatures.

What is the geometrical meaning of the system (29) plus (30)? The scalar curvatures R and \underline{R} are opposite. We may give a didactic image of this new geometrical framework. First, remember that the structure corresponds to a two-folds cover of a manifold. We get two distinct folds, with coupled metrics \mathbf{g} and $\underline{\mathbf{g}}$. They are not independent, for they are solution of the field equation system. They produce their own system of geodesics and the image, in fold \underline{F} , of a geodesic of fold F is not a geodesic of that twin fold \underline{F} . Light follows null-geodesics in both folds, but no null-geodesic links the two, so that the structure of one fold are geometrically invisible for an observer located in the other one. Assume now a mass is present in fold F , while the adjacent portion of fold \underline{F} is empty. The corresponding field equations system would be:

$$\mathbf{S} = \chi \mathbf{T} \qquad \underline{\mathbf{S}} = - \chi \mathbf{T}$$

Assume this mass distribution corresponds to a sphere with radius r_0 , filled by constant density material, and surrounded by void. Then the geometry, in fold F , in steady state is assumed, corresponds to two linked Schwarzschild solutions (internal and external). They are solutions of equation (68). In fold \underline{F} we get a *conjugated geometry*, with opposite scalar curvature $\underline{R} = -R$. Outside the sphere (and outside the corresponding adjacent space in fold \underline{F}) $R = \underline{R} = 0$. Inside the scalar curvatures are constant. The didactic model corresponds to a blunt “posicone”, associated to a “blunt negacone”, as shown on figure 15. In a blunt “posicone” the central portion is a portion of a sphere.

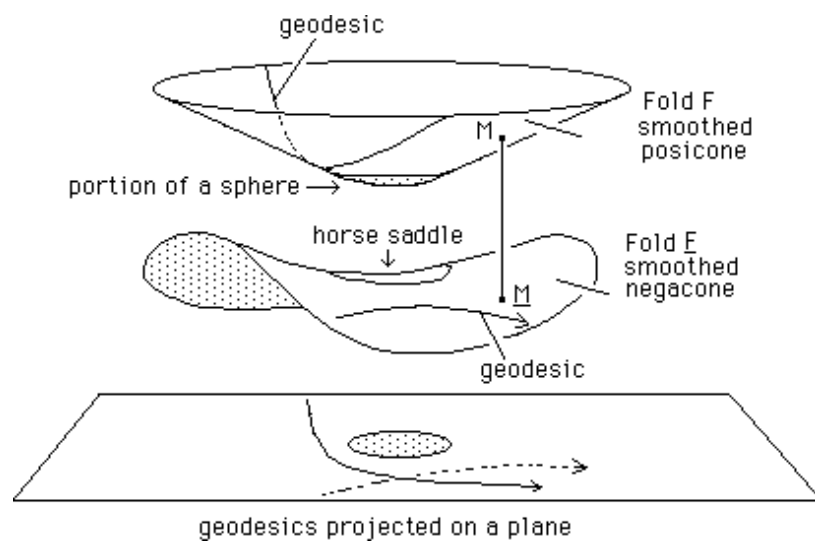

Fig.14: A mass is present in the fold F. Induced negative curvature in fold \underline{F}

In un “blunt negacone” the associated region corresponds, in this 2d didactic image, to a horse saddle. Below, a plane which figures how an observer located in fold F conceives this. He can observe both the mass M (grey disk) and the path of a mass cruising in his fold, “attracted by this mass”, this path, in this Euclidean representation corresponding to the projection of a geodesic of the “blunt posicone”. The observer cannot see the path of a particle of “twin matter”, cruising in the twin fold E and repelled by the mass.

Now, assume the mass is located in the fold E, in the twin space. The situations are reversed. See on figure 15. Following this 2d didactic image, the fold F is shaped as a blunt negacone, while the fold E looks like a blunt posicone. The geometry of F, close to the geometrical centre of the system evokes the vicinity of a twin matter clump located at the centre of a “cell” in the VLS. Light travelling in our fold can cross it, but it is sprayed. As evoked in section 3 and on figure 7 it implies that the clumps’ diameters could not be larger than a certain value, to be computed, in order to fit the available observations. Below: two plane representations showing Euclidean projections (how an observer could conceive the phenomenon, when located in fold F or in fold E).

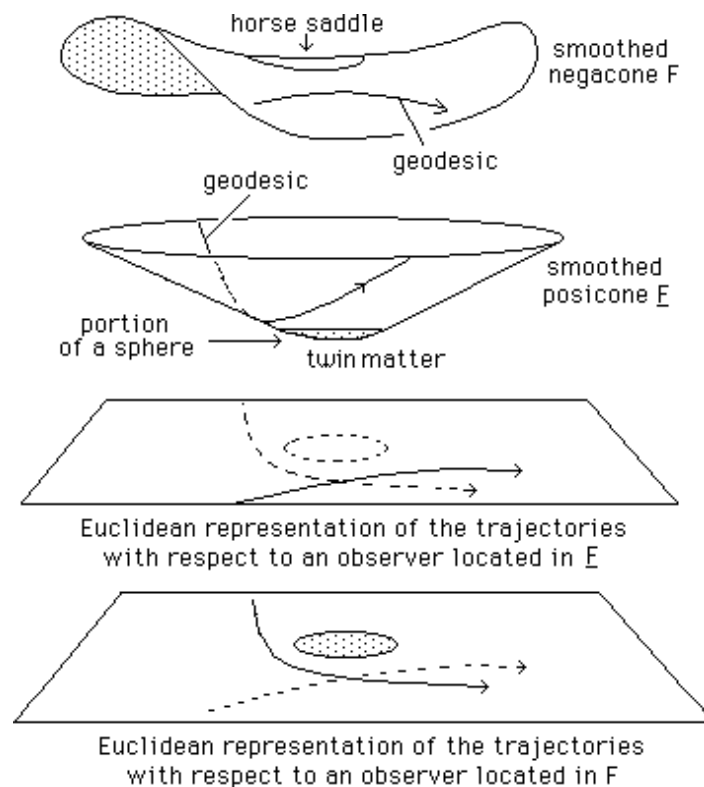

Fig.15: A mass of “twin matter” is present in the fold E, while the fold F is empty. It produces a negative (induced) curvature in F.

14- The radiative era.

Our field equations system is not compatible to the observational data for radiative era. An expansion corresponding to $R \approx \underline{R} \approx t$ is too slow. All the hydrogen would have been converted into helium, for a example. That’s for the radiative era corresponds to a different dynamics. The idea is that the so-called constants of physics behave like absolute constants during the matter era, but change drastically during the radiative era. It may look very artificial, but this idea may solve the

problem of the homogeneity of the early universe, as recently pointed out by several authors, like Magueijo (1999), but was discovered by the author 13 years before, at the end of the eighties ([44],[45], [46]) and developed later ([4] and[47]). First, notice that the choice of the time marker t remains arbitrary. It is nothing but “the way we think the things happened”. Absolute time has no meaning in cosmology. Any phenomenon does not “exist” if there is no observer in the Universe to look at it, to compare a succession of events to his proper time flow. At present time all is compared to the time of the observer, the way he lives. But past and future depends on the way he *imagines* it, for he cannot travel in past or future. Past and future are nothing but images we shape. We will say that these images are correct if they fit peculiar local phenomena, that we call “observations”, “measurements”. Consider the “constants of physics”. They were discovered quite recently. They are the light speed c , the gravitational constant G , the Planck constant h , the masses of particles, the unit electric charge e , the permittivity of vacuum ϵ_0 , and some others. Measurements performed in labs show no significant change. People have tried to study the impact over large period of time of a change of these constants on various cosmic phenomena. But they moved these constants one after the other, independently. In such conditions one can show that any light variation of an isolated constant produces contradictions with observational data. But what about joint variations? Surprisingly we may conceive a joint variation of all the constant, which cannot be evidenced in lab, for the lab’s instruments are built with the basic equations of physics. If this gauge process keeps these equations invariant, it will be impossible to evidence the variation of any constant, for the instruments and the constants they are supposed to measure experience parallel drifts. Imagine you want to measure the length of an iron table, with an iron scaled rule. Both are at room temperature. If the table’s length is found constant in time, you cannot swear this length does not vary, for this table and your scaled rule may experience a room temperature variation and expand in the same way. Let us search such basic gauge process. Consider for example the field equation, where we find the Einstein constant. We assume the divergence of this equation is zero which, in Newtonian approximation, corresponds to the conservation of matter and energy. If it is not, we must deal with source term. According to this hypothesis the Einstein constant χ must be an absolute constant. Does it imply that G and c must be absolute constants? Definitely not. It only implies that:

$$\chi = -\frac{8\pi G}{c^2} \text{ is an absolute constant} \longrightarrow G(t) \approx c^2(t)$$

As introduced first in 1988 we assume that the energies, all kind of energies, are conserved, but not the masses, electric charge and so on. This gives, for example:

$$E = \frac{m c^2}{\sqrt{1 - \frac{v^2}{c^2}}} = \text{constant} \longrightarrow m \approx \frac{1}{c^2} \approx \frac{1}{G} \quad \text{and} \quad v \approx c$$

In physics all students know the technique called dimensional analysis. Given a physical problem, ruled by an equation, or a set of equations, we produce characteristic lengths, times and numbers, composed with constants and laboratory condition data. Now we consider that all what is present in the equation may vary, including the “constants”. We put everything into a non-dimensional form. Consider for example the Boltzmann equation:

$$\frac{\partial f}{\partial t} + \mathbf{v} \cdot \frac{\partial f}{\partial \mathbf{r}} - \frac{\partial \phi}{\partial \mathbf{r}} \frac{\partial f}{\partial \mathbf{v}} = \int (f' f'_1 - f f_1) g a da d\omega d^3 \mathbf{v}$$

We introduce a characteristic length scale R and a characteristic time scale T:

$$f = \frac{n}{\langle V \rangle^3} e^{-\frac{v^2}{\langle V \rangle^2}} = \frac{1}{R^3 c^3} \eta \quad n = \frac{1}{R^3} \varpi \quad \phi = \frac{G m}{R} \varphi \quad t = T \tau \quad \mathbf{r} = R \boldsymbol{\zeta} \quad \mathbf{v} = c \boldsymbol{\xi} \quad \mathbf{g} = c \boldsymbol{\gamma} \quad a = R \alpha$$

The equation becomes:

$$\frac{1}{T} \frac{\partial \eta}{\partial \tau} + \frac{c}{R} \frac{\partial \eta}{\partial \boldsymbol{\xi}} - \frac{G m}{R^2 c} \frac{\partial \phi}{\partial \boldsymbol{\xi}} \cdot \frac{\partial \eta}{\partial \boldsymbol{\zeta}} = \frac{c}{R} \int (\eta' \eta'_1 - \eta \eta_1) \boldsymbol{\gamma} \alpha d\alpha d\omega d^3 \boldsymbol{\zeta}$$

$$\text{i.e.} \quad \frac{1}{T} \approx \frac{c}{R} \approx \frac{G m}{R^2 c} \quad \text{or:} \quad R = c T \quad \text{and:} \quad R \approx \frac{G m}{c^2} \approx R_s$$

We see that the Schwarzschild length varies like the scale factor R. To sum up get:

$$c \approx \frac{1}{\sqrt{R}} \quad \rho = n m \approx \frac{1}{R^2} \quad m \approx R \quad G \approx \frac{1}{R} \quad R \approx T^{\frac{2}{3}} \quad L_j \approx \frac{\langle V \rangle}{\sqrt{4 \pi G \rho}} \approx R \quad t_j \approx \frac{1}{\sqrt{4 \pi G \rho}} \approx T$$

We see that the Jeans length L_j varies like R, while Jeans time t_j varies like T. R and T are linked through a relation which evokes a Friedman model. But if one looks that closer and see it as a gauge relation, it means that the Kepler laws are also invariant: $T^2 \approx R^3$. By the way, introducing pressures (as energy densities) we get the gauge variations of these parameters and see that the subsequent energies are conserved (in this model all kinds of energy are conserved during the radiative era). We have figured the way the speed of light c varies with the energy density when radiation dominates.

$$\rho_r = \frac{\rho_r c^2}{3} \approx \frac{1}{R^3} \approx \rho_m = \frac{\rho_m c^2}{3} \quad \rho_r R^3 \approx \rho_m R^3 \approx \text{constant} \quad \rho \approx \rho_r \quad c \approx \rho_r^{\frac{1}{6}}$$

Now consider the Schrödinger equation:

$$-\frac{\hbar^2}{2m} (\Delta \Psi + U \Psi) = i \frac{\hbar}{2\pi} \frac{\partial \Psi}{\partial t}$$

Introduce non-dimensional potential expression and transform this equation:

$$\nabla = \frac{1}{R} \delta \quad U = \frac{\hbar^2}{2m R^2} u \quad -\frac{\hbar^2}{2m R^2} (\delta^2 \Psi + u \Psi) = i \frac{\hbar}{2\pi T} \frac{\partial \Psi}{\partial \tau} \quad \longrightarrow \quad \frac{\hbar}{m R^2} \approx \frac{1}{T}$$

$$\hbar v \approx \frac{\hbar}{T} \approx \text{constant} \quad L_p = \sqrt{\frac{\hbar G}{c^3}} R \quad t_p = \sqrt{\frac{\hbar G}{c^5}} \approx T \quad \lambda_c = \frac{\hbar}{m c} \approx R \approx \lambda_{db} = \frac{\hbar}{m v}$$

As a result, the energy is unchanged by this gauge process. The Planck constant h grows with T, as conjectured first by Milne [48]. The characteristic lengths: Planck length L_p , Compton λ_c and de

Broglie λ_{db} wavelengths vary like the space scale factor R, while the Planck time t_p varies like the time scale factor T. From this point of view, the evolution, during the radiative era is conceived as a gauge process. This makes the “Planck barrier” questionable. Does the “pre-quantic” epoch has a real meaning? Now, to finish the job we have to deal with Maxwell equations.

$$\nabla \times \mathbf{B} = \mu_0 \mathbf{J} + \frac{1}{c^2} \frac{\partial \mathbf{E}}{\partial t} \quad \nabla \times \mathbf{E} = - \frac{\partial \mathbf{B}}{\partial t} \quad \nabla \cdot \mathbf{B} = 0 \quad \nabla \cdot \mathbf{E} + \frac{\rho_e}{\epsilon_0} = 0 \quad \mathbf{J} = \frac{e^2}{m_e Q \langle V_e \rangle} \mathbf{E}$$

$$Q = \frac{4 \pi e^4 (\epsilon_0)^2}{m_e^2 \langle V_e \rangle^2} \quad \mathbf{E} = E \boldsymbol{\epsilon} \quad \mathbf{B} = B \boldsymbol{\beta} \quad \rho_e = \frac{e}{R^3} \omega_e \quad \nabla = \frac{\partial}{\partial \boldsymbol{\zeta}} = \boldsymbol{\delta} \quad E \approx cB$$

Continue to perform that sort of “generalized dimensional analysis”. We get:

$$\frac{B}{R} \boldsymbol{\delta} \times \boldsymbol{\beta} = \frac{\langle V_e \rangle \mu_0 E}{e^2 (\epsilon_0)^2} \frac{\boldsymbol{\epsilon}}{4 \pi} + \frac{E}{c^2 T} \frac{\partial \boldsymbol{\epsilon}}{\partial t} \quad \frac{E}{R} \boldsymbol{\delta} \cdot \boldsymbol{\epsilon} + \frac{e}{\epsilon_0 R^3} \omega_e = 0$$

$$\frac{B^*}{R} = \frac{\langle V_e \rangle \mu_0 E^*}{e^2 (\epsilon_0)^2} = \frac{E^*}{c^2 T} \quad \frac{E}{R} \approx \frac{e}{\epsilon_0 R^3} \rightarrow E \approx \frac{e}{\epsilon_0 R^2}$$

(Coulomb law)

In order to maintain the structure of the atoms during the evolution process we assume the fine structure constant is an absolute constant, which gives the whole solution:

$$\alpha = \frac{e^2}{\epsilon_0 \hbar c} = \text{constant} \rightarrow e^2 \approx \epsilon_0 R \quad \frac{c \mu_0}{e^2 (\epsilon_0)^2} = \frac{1}{c^2 T} \quad \mu_0 \epsilon_0 = \frac{1}{c^2} \quad e^2 \epsilon_0^3 \approx R \rightarrow \epsilon_0 = \text{constant}$$

We get easily:

$$e \approx \sqrt{R} \quad \mu_0 \approx \frac{1}{\epsilon_0 c^2} \approx R \quad E_1(\text{Rydberg}) = \frac{e^2}{\epsilon_0 R^2} = \text{constant} \quad Q = \frac{4 \pi e^4 \epsilon_0^2}{m_e^2 V_e^4} \approx R^2 \quad R_b = \frac{\hbar^2}{m_e e^2} \approx R$$

$$E \approx \frac{e}{\epsilon_0 R^2} \approx \frac{1}{R^{3/2}} \approx \frac{1}{T} \quad B \approx \frac{E}{c} \approx \frac{1}{R} \quad E_{\text{electr.}} = R^3 \epsilon_0 E^2 \approx \text{cst} \quad E_{\text{magnet.}} = R^3 \frac{B^2}{\mu_0} \approx \text{cst}$$

As we can see, during the radiative era, is the cosmic evolution is identified to a gauge process, all characteristic lengths vary like R (above, the Bohr radius), all the characteristic times vary like T, all the energies are constant. Q is a Coulomb cross-section, which $\approx R^2$. Similarly the associated mean free path and the Debye length $\approx R$, and so on. All the constants, space and time scales are involved in this gauge process, which can be described choosing any of them. We can take T as our time-marker t .

$R \approx t^{2/3}$	$G \approx t^{-2/3}$	$m \approx t^{2/3}$	$\hbar \approx t$
$c \approx t^{-1/3}$	$\rho \approx t^{-2/3}$	$p \approx t^{-2}$	$v \approx t^{-1/3}$
$e \approx t^{1/3}$	$E \approx t$	$B \approx t^{-2/3}$	$\mu_0 \approx t^{2/3}$

Next, the variation of the constants, during the radiative era, versus the radiative pressure p_r :

$$G = G_0 \sqrt[3]{p_r} \quad m = \frac{m_0}{\sqrt[3]{p_r}} \quad h = \frac{h_0}{\sqrt{p_r}} \quad c = c_0 \sqrt[6]{p_r} \quad e = \frac{e_0}{\sqrt[6]{p_r}}$$

If we assume that the values of the constants depend on the radiative pressure, introducing a critical value p_{cr} , to be defined, we can write:

$$G = G_0 \sqrt[3]{1 + \frac{p_r}{p_{cr}}} \quad m = \frac{m_0}{\sqrt[3]{1 + \frac{p_r}{p_{cr}}}} \quad h = \frac{h_0}{\sqrt{1 + \frac{p_r}{p_{cr}}}} \quad c = c_0 \sqrt[6]{1 + \frac{p_r}{p_{cr}}} \quad e = \frac{e_0}{\sqrt[6]{1 + \frac{p_r}{p_{cr}}}}$$

G_0 , m_0 , h_0 , c_0 , e_0 correspond to the today's values. We assume that this critical conditions are achieved for a value $t = t_{cr}$ of the chosen time-marker and we introduce a non-dimensional variable $\tau = t / t_{cr}$. Then we can write:

$$G = G_0 \sqrt[3]{1 + \frac{1}{\tau^2}} \quad m = \frac{m_0}{\sqrt[3]{1 + \frac{1}{\tau^2}}} \quad h = \frac{h_0}{\sqrt{1 + \frac{1}{\tau^2}}} \quad c = c_0 \sqrt[6]{1 + \frac{1}{\tau^2}} \quad e = \frac{e_0}{\sqrt[6]{1 + \frac{1}{\tau^2}}}$$

which corresponds to figure 16:

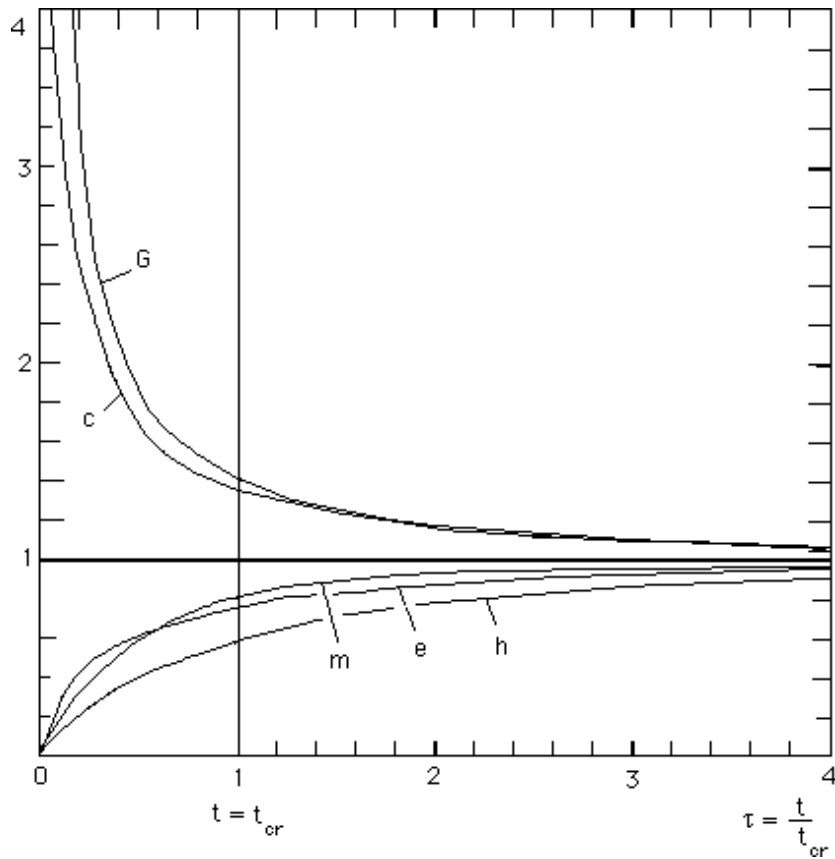

Fig. 16: Variation of the constants during the radiative era.
 $\tau \gg \tau_{cr}$ corresponds to matter era

15- The homogeneity of the Universe.

Any model requires an observational confirmation. Figure 17, left, the classical paradox of the homogeneity of the early Universe. “Classical explanation”: the “Inflation Theory”, requiring heavy hypothesis. Today, some people begins to think about a variable constants model, including a secular variation of c . The called it “VLS”: “variable light speed”. In fact I developed this idea in 1988 [44]. With the suggested time-variation of c , which with the precedent section the horizon varies like $R(t)$ which ensures homogeneity at any time.

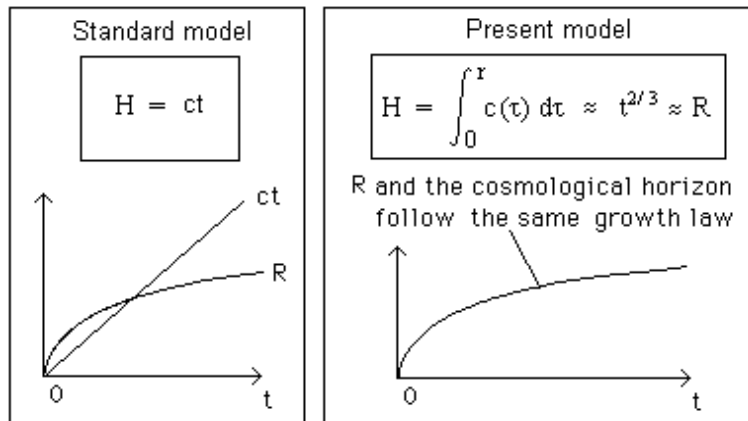

Fig. 17: The horizon, according to the standard model and to the present model.

16- When the adverb “before” fails.

As said above, a time marker corresponds to an arbitrary choice. It has no intrinsic meaning. In the standard model if we deal with the distant past of the Universe, the temperature rises and elements’ velocities tend to c . All particles become relativistic, so that a question arises: “how to build a clock, with which material?”. When we look at a clock, what do we look at? To the rotation of a needle. A turn corresponds to a minute, or hour. A turn of the Earth around the Sun corresponds to a year. Whatever we call it, this 360° rotation has a physically real meaning. It is an undeniable event. Similarly we can consider a reference system composed by two masses m orbiting around their common centre of gravity. We may call it our “elementary clock”. In a gas at thermodynamic equilibrium the available energy is distributed in translational energy, the rotational energy, vibrational energy. A couple of particles orbiting around their common centre of gravity is conceivable if the energy of the system is comparable to the energy of free particles, which cruise around. In a variable constant system this is possible. Then we can count the number of turns, using the time-marker t , which has no real significance: it’s only a chronological marker.

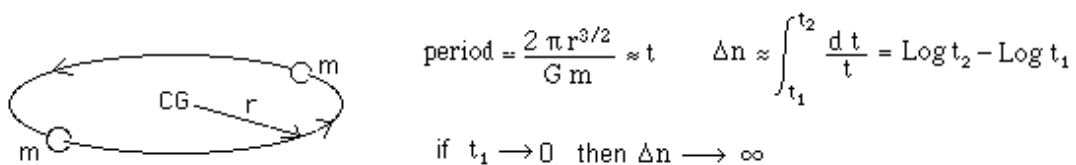

Fig.18: The elementary clock.

$$L_j = \sqrt{\frac{k T_o}{4 \pi G \rho_o m}}$$

$$\underline{L}_j = \sqrt{\frac{k T_o}{4 \pi G \underline{\rho}_o m}}$$

$\Delta \delta \rho + \frac{\delta \rho - \underline{\delta \rho}}{L_j^2} - \frac{m}{k T_o} \frac{\partial^2 \delta \rho}{\partial t^2} = 0$	$\Delta \underline{\delta \rho} - \frac{\delta \rho - \underline{\delta \rho}}{\underline{L}_j^2} - \frac{m}{k T_o} \frac{\partial^2 \underline{\delta \rho}}{\partial t^2} = 0$
--	--

A steady-state spherically symmetric solution, with initial conditions:

$$(\delta \rho_o = \underline{\delta \rho}_o, T = \underline{T}, \langle V \rangle = \langle \underline{V} \rangle):$$

$$\delta \rho = \delta \rho_o e^{-\frac{m \delta \Psi}{k T_o}} \quad \underline{\delta \rho}^* = \underline{\delta \rho}_o^* e^{\frac{m \delta \Psi}{k T_o^*}}$$

On figure 19 the typical numerical solution.

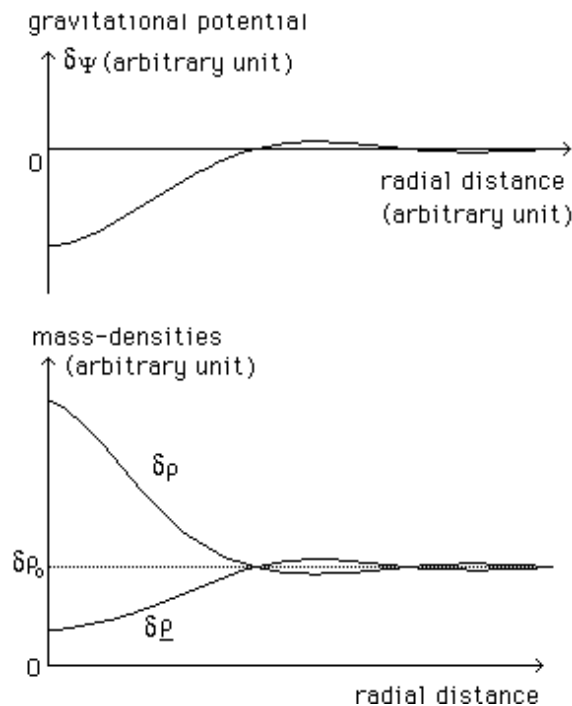

Fig. 19: Joint gravitational instabilities. Formation of a clump of matter surrounded by repulsive twin matter environment.

18- The confinement of spheroidal galaxies.

In section 7, figure 11, we said that the field due to a hole in a uniform negative energy matter was equivalent to the field created by an equivalent sphere, filled by positive energy matter and surrounded by void. It has now to be justified. Let us recall how the link to Poisson equation is built in classical theory (see for example[52]). We start from a perturbed Lorentz metric $\mathbf{g} = \mathbf{g}_L + \epsilon \mathbf{\Upsilon}$ where ϵ is a small parameter. The geometric tensor is expanded into a series, as well as the energy-matter tensor, limited to the ρ term. This gives (a):

(a)	$-\sum_{i=1}^3 \gamma_{00i1i} = \chi \rho$	(b)	$-\left(\frac{\partial^2 \gamma_{00}}{\partial x^2} + \frac{\partial^2 \gamma_{00}}{\partial y^2} + \frac{\partial^2 \gamma_{00}}{\partial z^2} \right) = \chi \rho$	(c)	$\chi = -\frac{8\pi G}{c^2}$ (Einstein's constant)		
(d)	$\Psi = \frac{c^2}{2} \varepsilon \gamma_{00}$	(e)	$\frac{d^2 \Psi}{dr^2} + \frac{2}{r} \frac{d\Psi}{dr} = 4\pi G \rho$	(f)	$\Psi = \frac{2}{3} \pi G \rho r^2 + \text{constant}$	(g)	$g_r = -\frac{4}{3} \pi G \rho r$

The one writes (b). With (d) and (c) the equation (b) is identified to Poisson equation. But notice immediately that the given perturbed metric corresponds to steady-state conditions. This is conceivable only if the zero order solution (the Lorentz metric) corresponds to an empty universe, where no gravitational force and no pressure are acting. Then we can perturb it with a steady state term $\varepsilon \Psi$, assuming that this perturbation is weak enough to do prevent the collapse of the universe, due to gravitational force. Then there is a link between the field and the Poisson equations. But is the Universe is supposed to be non-empty and uniform this method does not hold any longer, for we cannot refer to steady state metric. What is the impact? We cannot define a gravitational potential in an uniform universe, filled by constant density material. If we look at the Poisson equation (e), written in spherical coordinates and if we suppose ρ is a constant, we find the spherically solution (f) and the corresponding gravity field is (g). Isn't surprising to find a non-zero gravitational force, pointing towards an arbitrary centre of coordinates and tending to infinite with radial distance? Explanation: this pseudo-solution is not correct, for Poisson equation does not exist in an steady state uniform universe. The field is zero everywhere, which looks more physical.

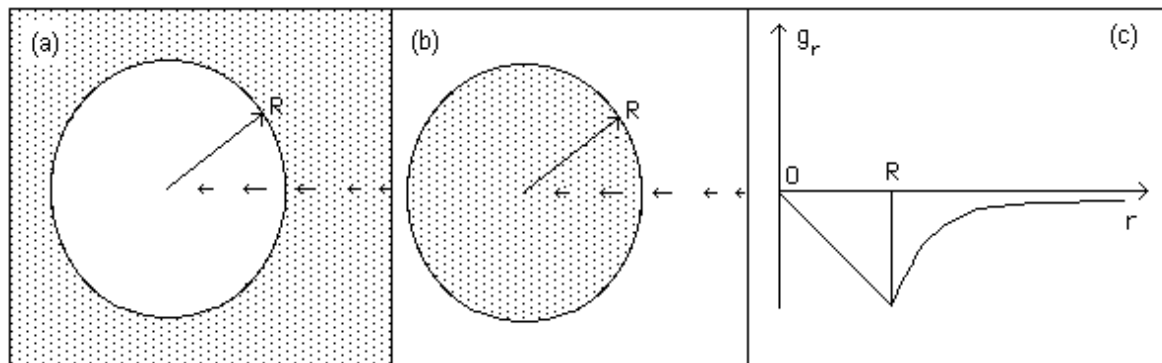

Fig. 20: Spherical hole in a constant density twin matter distribution and associated gravitational potential.

The figure (b) shows the gravitational field around and inside a sphere filled by constant positive density material (like the Earth). In (c) the associated gravitational potential. If we reverse the arrows of (b) we get the field associated to a sphere filled by negative mass. If this is added to (a) we get an uniform and unbounded region, filled by negative mass, with a zero field, so that (a) figure the field inside a spherical cavity, which is non-zero. We get a confining effect and the intensity of the field is maximum at the internal border. This explains why the spiral galaxies keeps their arms and why the decrease of the gas density of the disk is so abrupt at periphery.

19- What twin matter could be made of.

Theoretical physics is in a big crisis since more than 30 years. A lot of papers were published many years ago about magnetic monopole, but no one appeared. The existence of supersymmetric partners has not been proved yet. Nobody knows what a “graviton” could be. When scientists tried to evidence the proton’s decay, this last did not cooperate. Almost all that new telescopes bring is still a complete mystery. Nobody knows what are QSO, gamma flashes and how it works. Giant black holes are strangely silent, and so on. Superstring is nothing but a new fashion, in spite thousands papers published in this “new field”. Superstring world is a strange play field in which physics seems desperately absent. In the following we give the first geometrical description of antimatter. As J.M.Souriau uses to say, group theory is the most basic tool we have to deal with physical phenomena. A natural action of a Lie group is its coadjoint action on its Lie algebra, as introduced by J.M.Souriau in 1970 [53]. The dimension of a group G is the number of parameters it depends on. This is also the number of components of its moment \mathbf{J} . The Lorentz group L is a six-dimensional group, which owns four connex components. Introduce the four elements group Ω , in its matrix representation (a). Then we can build the complete Lorentz group L from its neutral component L_n , through a direct group product (b), where (c) is the matrix representation. A new semi-direct product

(a)	$\Omega(\mu, \nu) = \begin{pmatrix} \mu & 0 & 0 & 0 \\ 0 & \mu & 0 & 0 \\ 0 & 0 & \mu & 0 \\ 0 & 0 & 0 & \nu \end{pmatrix} \begin{matrix} \mu = \pm 1 \\ \nu = \pm 1 \end{matrix}$	(b)	$L = \Omega \times L_n$	(c)	$L = \Omega L_n$	(d)	$P = (\Omega \times L_n) \times R^4$
(e)	$\xi = \begin{pmatrix} x \\ y \\ z \\ t \end{pmatrix}$	(f)	$C = \begin{pmatrix} \Delta x \\ \Delta y \\ \Delta z \\ \Delta t \end{pmatrix}$	(g)	$\begin{pmatrix} \Omega L_n & C \\ \mathbf{0} & 1 \end{pmatrix}$	(h)	$\begin{pmatrix} \Omega L_n & C \\ \mathbf{0} & 1 \end{pmatrix} \times \begin{pmatrix} \xi \\ 1 \end{pmatrix} = \begin{pmatrix} \Omega L_n \xi + C \\ 1 \end{pmatrix}$

(d) gives the Poincaré group. Introduce the event-fourvector ξ : (e) and the space-time translation vector C : (f). We can give a matrix representation (g) of the Poincaré element. In (h) its action on space-time. But this one hides a more important action: the coadjoint action of the group on its ten components moment space J (the Poincaré group owns ten dimensions). Souriau writes this moment:

$$\mathbf{J} = \{ E, \mathbf{p}, \mathbf{f}, \mathbf{l} \}$$

E is the energy, \mathbf{p} the impulsion, \mathbf{f} the “passage” and \mathbf{l} the spin. It is convenient to introduce, following Souriau, an antisymmetric matrix M : (a) and the quadrivector impulsion-energy P : (b). The calculation of the dual of the action of the group on its Lie algebra gives the action on the momentum { (c), (d) }.

(a)	$M = \begin{pmatrix} 0 & -l_z & l_y & f_x \\ l_z & 0 & -l_x & f_y \\ -l_y & l_x & 0 & f_z \\ -f_x & -f_y & -f_z & 0 \end{pmatrix}$	(b)	$P = \begin{pmatrix} \mathbf{p} \\ E \end{pmatrix}$	(c)	$M' = \Omega L_n M^t (\Omega L_n) + (C^t P^t (\Omega L_n) - \Omega L_n P^t C)$
				(d)	$P' = \Omega L_n P$
		(e)	$L_n = \mathbf{1}$	(g)	$M' = [\Omega(\mu, \nu)] \times M \times [\Omega(\mu, \nu)]$
		(f)	$C = \mathbf{0}$	(h)	$P' = [\Omega(\mu, \nu)] \times P$

Now, if we want to evidence symmetries **I** , **P** , **T** and **PT** we choose (e) and (f). The the coadjoint action becomes { (g) , (h) } , which gives:

(a) $E' = \nu E$ $\mathbf{p}' = \mu \mathbf{p}$ $\mathbf{f}' = \mu \nu \mathbf{f}$ $\mathbf{l}' = \mathbf{l}$	(b)	I $\mu=1; \nu=1$	P $\mu=-1; \nu=1$	T $\mu=1; \nu=-1$	PT $\mu=-1; \nu=-1$	(c) $\{ \Omega(1,1), \Omega(1,-1) \}$	
		E'	E	E	-E	-E	(d) $P_o = \{ P_n, P_s \}$
		\mathbf{p}'	\mathbf{p}	$-\mathbf{p}$	\mathbf{p}	$-\mathbf{p}$	(e) $\{ \Omega(1,-1), \Omega(-1,-1) \}$
		\mathbf{f}'	\mathbf{f}	$-\mathbf{f}$	$-\mathbf{f}$	\mathbf{f}	(f) $P_a = \{ P_t, P_{st} \}$
		\mathbf{l}'	\mathbf{l}	\mathbf{l}	\mathbf{l}	\mathbf{l}	

As pointed out in 1970 by J.M.Souriau, with the matrixes (c) we build the P_o : (d), composed by two connex components: the neutral one P_n and by the space-inversion component P_s . The terms of these two components do not inverse the sign of the energy E. Conversely, the matrixes (e) produce the antichron subset, whose terms inverse the sign of the energy, so that time-inversion goes with energy inversion, i.e. mass-inversion, if the particles own one. As a conclusion we see that negative mass and negative energy arise from the dynamic Poincaré group description, referring to relativistic mass-point movements. Now, we are going to extend the Poincaré group, considering:

$$O(2) \times P = O(2) \times (L \times R^4)$$

We introduce the matrix (a) and (b). Then we give a matrix representation of the group, acting (e) on a bundle $Z \times U(1) \times R^4$. In (f) we get the geometrical expression of the C-symmetry. The fifth dimension (c) is compact. Then any element of the group corresponding to choices (f) implies a

(a) $\epsilon(\lambda\mu\nu) = \begin{pmatrix} \frac{1}{2}(1+\lambda\mu\nu) & \frac{1}{2}(1-\lambda\mu\nu) \\ \frac{1}{2}(1-\lambda\mu\nu) & \frac{1}{2}(1+\lambda\mu\nu) \end{pmatrix}$	(b) $M(\phi) = \begin{pmatrix} \cos\phi & -\sin\phi \\ \sin\phi & \cos\phi \end{pmatrix}$	(d) $\lambda\mu\nu=+1 \rightarrow \epsilon = \epsilon_{+1} = \begin{pmatrix} 1 & 0 \\ 0 & 1 \end{pmatrix}$ $\lambda\mu\nu=-1 \rightarrow \epsilon = \epsilon_{-1} = \begin{pmatrix} 0 & 1 \\ 1 & 0 \end{pmatrix}$
(c) $z = e^{i\theta} = \begin{pmatrix} \cos\theta \\ \sin\theta \end{pmatrix}$	(e) $\begin{pmatrix} \nu & \mathbf{0} & \mathbf{0} & 0 \\ \mathbf{0} & \epsilon M(\phi) & \mathbf{0} & \mathbf{0} \\ \mathbf{0} & \mathbf{0} & \Omega L_n & \mathbf{C} \\ \mathbf{0} & \mathbf{0} & \mathbf{0} & 1 \end{pmatrix} \times \begin{pmatrix} f \\ z \\ \xi \\ 1 \end{pmatrix} = \begin{pmatrix} \nu f \\ \epsilon M(\phi) z \\ \Omega L_n \xi + \mathbf{C} \\ 1 \end{pmatrix}$ $\epsilon = \epsilon(\lambda, \mu, \nu)$ $\Omega = \Omega(\mu, \nu)$ $f = \pm 1$ $\lambda = \pm 1$ $\mu = \pm 1$ $\nu = \pm 1$	(f) C-symmetry $\lambda = +1 \quad \mu = +1 \quad \nu = -1$ $y = t_g(\frac{\pi}{4} + \phi) \times$

symmetry with respect to the indicated straight line. The calculation of the coadjoint action of the group on its momentum shows no peculiar difficulty. As pointed out by Souriau in 1970 the addition compact dimension θ goes with a quantified additional scalar, identified to the electric charge q. The action on the part of the moment corresponding to Poincaré does not change. The action on the electric charge gives:

$$q' \lambda \mu \nu q$$

Particles are describes in terms of orbits of the group. Some own a positive energy and others a negative one. f can be considered as a fold index.

$f = +1$ refers to fold F

$f = -1$ refers to fold \underline{F}

Wet get a geometrical twin structure. The action is simply:

$$f' = \nu f$$

This can be summarized on figure 21.

		I	C	P	T	CP	CT	PT	CPT
		$\lambda = 1$	$\lambda = -1$	$\lambda = 1$	$\lambda = 1$	$\lambda = -1$	$\lambda = -1$	$\lambda = 1$	$\lambda = -1$
		$\mu = 1$	$\mu = 1$	$\mu = -1$	$\mu = 1$	$\mu = -1$	$\mu = 1$	$\mu = -1$	$\mu = -1$
		$\nu = 1$	$\nu = 1$	$\nu = 1$	$\nu = -1$	$\nu = 1$	$\nu = -1$	$\nu = -1$	$\nu = -1$
electric charge	q'	q	$-q$	$-q$	$-q$	q	q	q	$-q$
energy	E'	E	E	E	$-E$	E	$-E$	$-E$	$-E$
impulsion	\mathbf{p}'	\mathbf{p}	\mathbf{p}	$-\mathbf{p}$	\mathbf{p}	$-\mathbf{p}$	\mathbf{p}	$-\mathbf{p}$	$-\mathbf{p}$
passage	f'	f	f	$-f$	$-f$	$-f$	$-f$	f	f
spin	\mathbf{l}'	\mathbf{l}	\mathbf{l}	\mathbf{l}	\mathbf{l}	\mathbf{l}	\mathbf{l}	\mathbf{l}	\mathbf{l}
fold index	f'	f	f	f	f	$-f$	$-f$	$-f$	$-f$

Fig. 21: Impact of symmetries on the momentum components.

Notice that ($\nu = -1$) refers to antichron terms of the group. A particle and its movement correspond to a peculiar element of the momentum. Antichron terms transform orthochron movements into antichron ones and reverse mass and energy. As space time is composed by two separate folds F and \underline{F} , encounters of opposite energy particles can be avoided if we put positive energy particles in one fold, F for example, and negative energy in its twin fold \underline{F} . This physical description is consistent to the group properties.

20- PT-Symmetry and CPT-symmetry.

As pointed out by Souriau in 1970, all symmetry which includes a T-symmetry reverse the energy and the mass. If we consider a normal particle, with mass m and electric charge q , its CPT-symmetrical owns negative energy and mass. Feynman showed that the PT-symmetrical of a particle behaved as an antiparticle, but, according to Souriau's result, it owns negative mass and energy.. From above, we have built a new description of the Universe as composed by two twin entities. The first is a fold F , supposed to be ours, filled by matter and Dirac-antimatter, C-symmetrical with respect to the first. In the second fold \underline{F} the matter-antimatter duality holds too. Its matter is CPT-symmetrical with respect to ours, while its antimatter identifies to Feynman one. As a whole, the two folds are CPT symmetrical. This goes with initial Sakharov's ideas ([33] to [36]). The initial work of the author, devoted to twin Universe cosmology, was published in 1977.

21- Leaking neutron star model: a challenger to black hole model.

Classically the criticality of a neutron star is based on a geometrical criticality. A constant density sphere, surrounded by void can be described by two linked Schwarzschild metric (internal and external). These expressions have been give in section 7. Both become critical when the neutron star's radius tends to its associated Schwarzschild radius. Tolmann, Oppenheimer and Volkov derived (see [52], eq. 144.22) a famous "TOV equation" giving pressure versus radial distance in a neutron star.

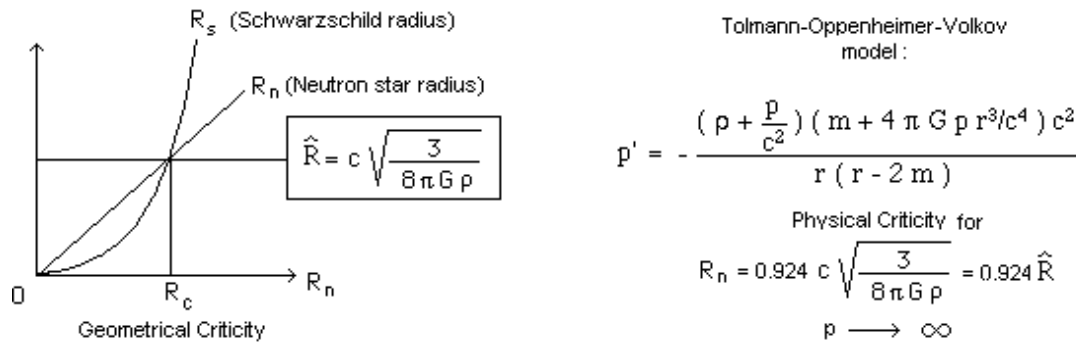

Fig. 22: Left, geometrical criticality. Right: physical criticality.

The calculation shows that, before the geometrical conditions are reached, a physical criticality occurs: pressure tends to infinite at the centre of the star (left).

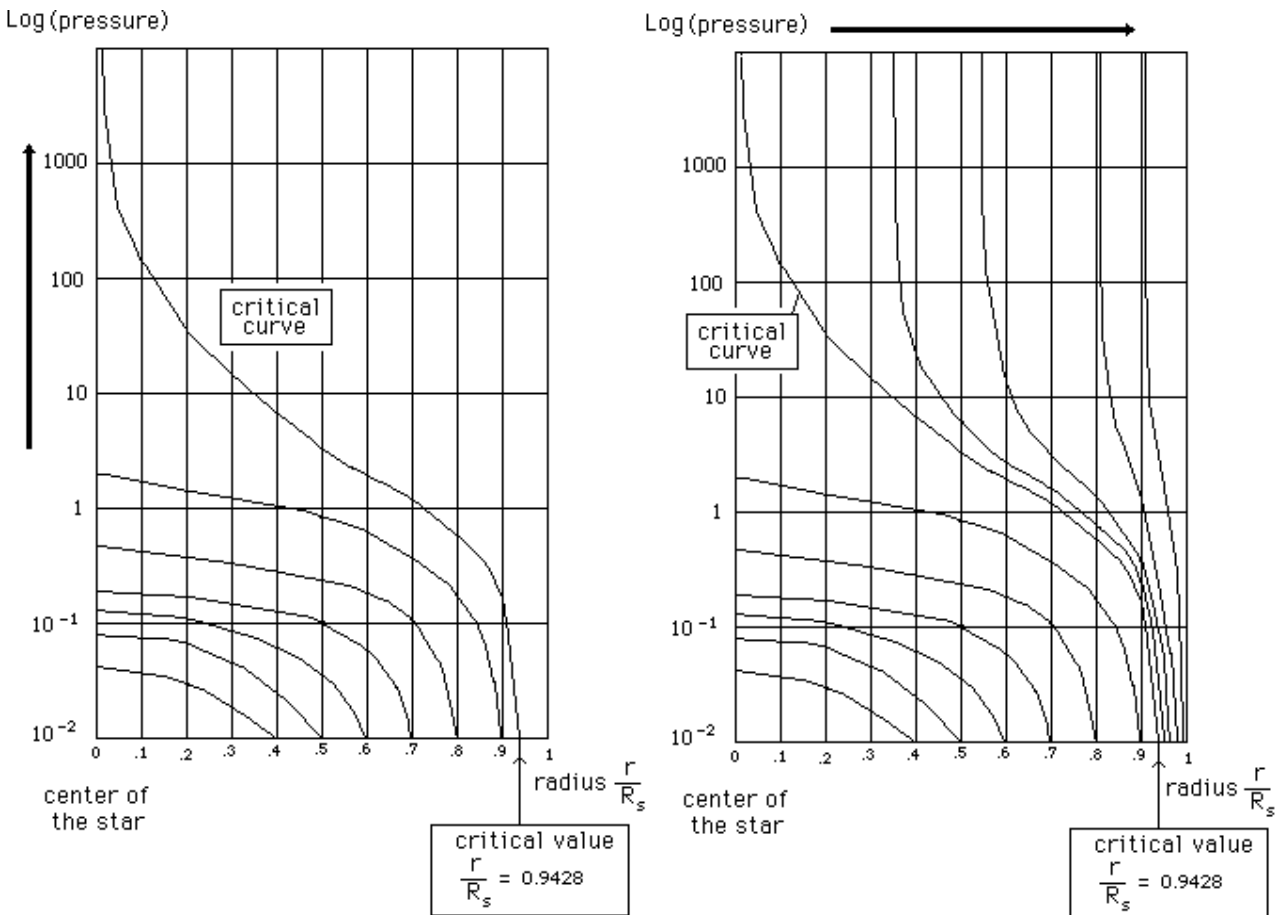

Fig. 23: Pressure versus radial distance in a neutron star.

We are going now to make assumptions. In section 15 we tried to describe the primitive stage of the Universe, going backward in its past. In order to explain its great homogeneity we introduced a variation of the constants of physics, during the radiative era. By the way, this exploration is still very hazardous. We only tried to give new insights on the question: “What happens when we look at the distant past of the Universe?”

I think we don't own all the keys. I will just expression an opinion. I would think that when the pressure reaches a critical value (to be determined) our Universe becomes linked to its twin which, as A. Sakharov suggested “lies in its past”. Although it is still confused, I admit, I think that our universe interacts with its past, which would extends over some sort of space-time bridge. Sakharov thought that our Universe and its twin were linked. I add they would be interacting, everywhere, all the time. That's for the arrow of time is found to be reversed in the twin, from section 19. That's for the twin's atoms seem to own a negative mass and repel ours. For us, they just live backward in time, that's for, according to Souriau's works, their *apparent mass* is negative. By analogy I would think that when *physical* criticity is reached at the centre of a neutron star, the local values of the constants of physics change drastically. Such condition would “reproduce” locally the “Big Bang conditions”. A spaced bridge would open, sucking matter at relativistic velocity. Such “soft scenario” would occur when the matter's flux due to the solar wind of a companion star achieves critical conditions at the centre of the star.

Then a steady state can be geometrically described, using the four Schwarzschild metrics.

For fold F:

$$ds^2 = \left[\frac{3}{2} \sqrt{1 - \frac{r_0^2}{\hat{R}^2}} - \frac{1}{2} \sqrt{1 - \frac{r^2}{\hat{R}^2}} \right]^2 c^2 dt^2 - \frac{dr^2}{1 - \frac{r^2}{\hat{R}^2}} - r^2 (d\theta^2 + \sin^2\theta d\phi^2) \text{ for } r \leq r_0 \quad \hat{R}^2 = \frac{3c^2}{8\pi G\rho}$$

For the adjacent, conjugated region of the twin fold F:

$$ds^{*2} = \frac{B}{\sqrt{1 + \frac{r^2}{\hat{R}^2}}} c^2 dt^2 - \frac{dr^2}{1 + \frac{r^2}{\hat{R}^2}} - r^2 (d\theta^2 + \sin^2\theta d\phi^2) \text{ for } r \leq r_0 \quad \hat{R}^2 = \frac{3c^2}{8\pi G\rho}$$

One can study the geodesic systems and link them, through a space bridge whose single parameter is its area. Tiny space bridges can absorb the matter corresponding to stellar wind of a companion star, for, close to it, the density is enormous and the velocity relativistic. On figure 24 a 2d didactic image of the model:

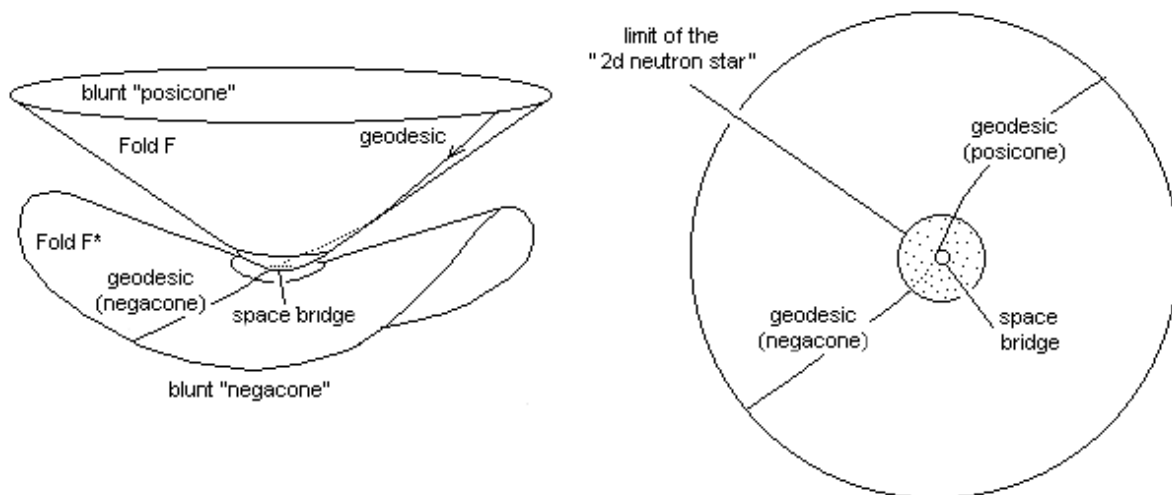

Fig. 24: 2d didactic image of a sleaking neutron star (SNS).

A violent inflow of matter, due for example to more eruptive phenomena of a companion star or to the fusion of two neutron stars, forming a binary system, could produce fast opening of a space bridge, as suggested on the right of figure 24. The explanation of gamma bursts could lie there.

This model challenges the black hole model. We will see further how this last is questionable. Something goes wrong with this black hole model. There are too few candidates and everybody knows that a slight error about distance evaluation can convert such black holes candidates into simple neutron stars. There is no undeniable proof of their existence. People only *believe* in. They always said: “what could you imagine else?”.

Look at the beginning of the paper. We evoked the issue of the newspaper *Le Monde* in which Fort and Meillier presented a coloured 3d map of dark matter and the journalist, enthusiastic, titled [1]: “The dark matter does exist: it bends the light rays”. But what about the “dark clusters” [2], discovered by the same people, which “attract the light rays, bend it, but apparently repel the ordinary matter”. If this is confirmed they would be made, as suggested by Fort, exclusively of “exotic matter”, and if they are, what is that stuff? What about the acceleration of the space probes [49], that a dark matter distribution cannot explain?

Today people *need* to find giant black holes at the centre of galaxies, in order to justify the dynamical parameters of such regions. But these giants seem very silent, like sleeping beauty, don’t they? Some suggested they could be “satiated black holes”. How long time will we try to answer these problems just inventing new names.

22- Black holes do not exist.

Where the black hole model does come from? From the null second member field equation. Paradoxically such very dense object rises from an equation which was initially built to describe empty regions of the Universe. The Kerr metric does not bring so much: the object becomes more complex, that's all. Rotation brings an azimuthal frame-dragging phenomenon, which means that the speed of light is different if one looks forward or backward with respect to the spinning movement. Whatever is the technique you choose, the things become frankly pathological when you pass the horizon and get in. At the centre lies "the singularity". Let us start with an exercise. Consider the 2d metric (a). If we consider r as a radial distance and φ as a polar angle, we get problems for $r < R_s$. But if we introduce the change (b) the expression of the metric becomes (c). All pathologies disappear. Moreover this surface can be imbedded in R^3 : the meridian equation is (d). See figure 25 where we have figured a geodesic. This illustrates the fact that a pathology can depend on a wrong choice of coordinates and on a wrong choice of topology.

In the 3d example we have computed (plane) geodesics (see figure 26) which are projected on the initial (r, θ, φ) representation space. We get a "throat sphere" linking two Euclidean 3d spaces. There is nothing inside. Space for $r < R_s$ has no physical meaning. If we would try to compute geodesics in that place, we would find an imaginary solution. Oppositely, in (ρ, θ, φ) coordinates, all pathologies disappear. The geodesic system becomes regular. By the way, in (e) we recognize "the space part of the Schwarzschild metric".

(a) $ds^2 = \frac{dr^2}{1 - \frac{R_s}{r}} + r^2 d\varphi^2 = g_{rr} dr^2 + g_{\varphi\varphi} d\varphi^2$

(b) $r = R_s + \text{Log ch } \rho$

(c) $ds^2 = R_s^2 \left[\frac{1 + \text{Log ch } \rho}{\text{Log ch } \rho} \text{th}^2 \rho d\rho^2 + (1 + \text{Log ch } \rho)^2 d\varphi^2 \right]$

(d) $z = \pm 2 R_s \sqrt{\frac{r}{R_s} - 1}$

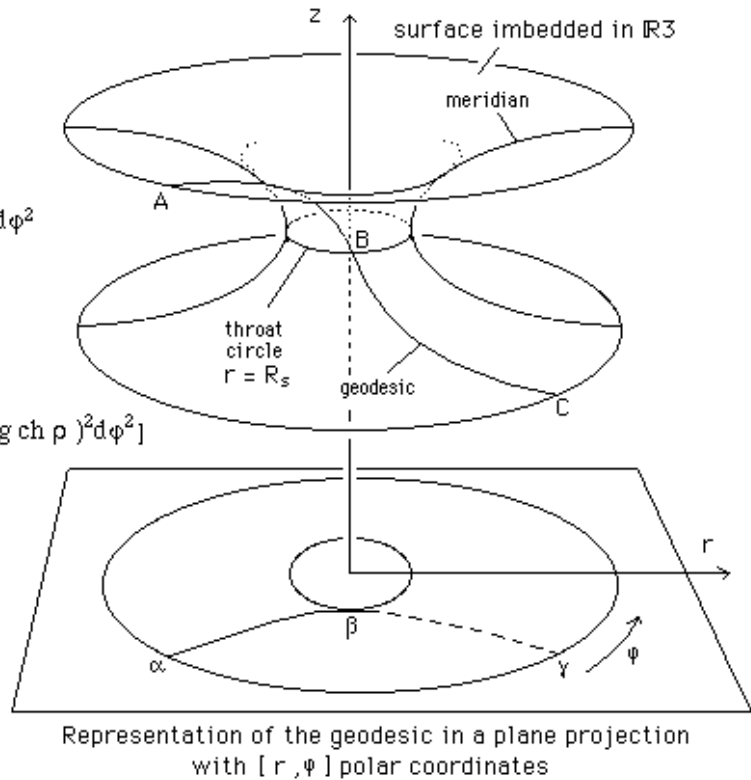

Fig. 25: 2d metric of a surface with a "bridge" linking two folds.

$$(e) \quad ds^2 = \left(1 - \frac{R_s}{r}\right) dx^{\circ 2} - \frac{dr^2}{1 - \frac{R_s}{r}} - r^2 (d\theta^2 + \sin^2\theta d\phi^2)$$

$$(f) \quad r = R_s + \text{Log ch } \rho$$

$$(g) \quad ds^2 = \frac{\text{Log ch } \rho}{1 + \text{Log ch } \rho} c^2 dt^2 - R_s^2 \left[\frac{1 + \text{Log ch } \rho}{\text{Log ch } \rho} \text{th}^2 \rho d\rho^2 + (1 + \text{Log ch } \rho)^2 (d\theta^2 + \sin^2\theta d\phi^2) \right]$$

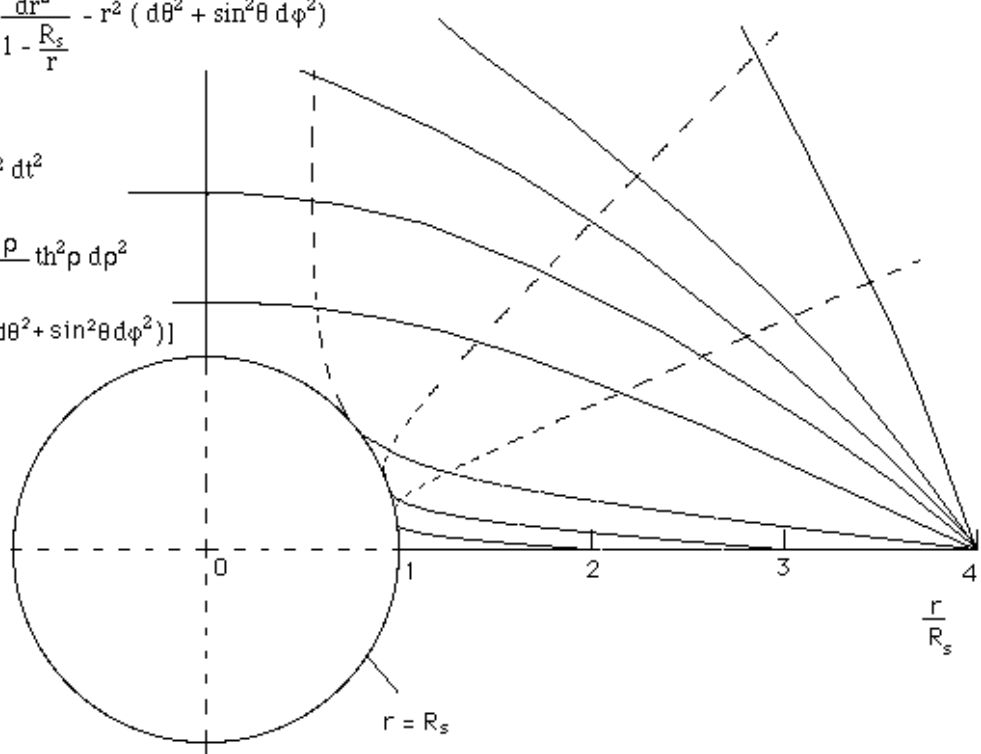

Fig. 26: 3d metric hypersurface with a “space bridge”. Geodesics.

Now, let us start from the Schwarzschild metric (h), written in classical coordinates $(x^\circ, r, \theta, \phi)$ where x° is nothing but a *time marker*. Classically, one introduces a proper time (j) and a “time-coordinate t (i). Then the study of radial geodesics gives two differential equations (k) and (l), whose solutions correspond to curves (m), fig. 6.2, reference [52].

(h) $ds^2 = \left(1 - \frac{R_s}{r}\right) dx^{\circ 2} - \frac{dr^2}{1 - \frac{R_s}{r}} - r^2 (d\theta^2 + \sin^2\theta d\phi^2)$		(i) $x^\circ = ct$	(j) $s = c\tau$
(k) $\frac{d\tau}{dr} = \pm \frac{1}{c} \sqrt{\frac{r}{R_s}}$	(l) $\frac{dt}{dr} = \pm \frac{1}{c} \sqrt{\frac{r}{r - R_s}}$	(m)	

The curves shown on figure (m) are the basis of the black hole model. One identifies the coordinate t to the proper time of a “distant observer” so that the free fall time of a test particle, towards the Schwarzschild Sphere become infinite for him. Let us show that this is completely due to this peculiar choice of time coordinate. In [54] 1925 Eddington suggested a new time-marker (p).

(p) $x^\circ = x - R_s \text{Log} \left \frac{r}{R_s} - 1 \right $ (Eddington, 1924)	(q) $ds^2 = \left(1 - \frac{R_s}{r}\right) c^2 dt^2 - \left(1 + \frac{R_s}{r}\right) dr^2 - 2 \frac{R_s}{r} c dt dr - r^2 (d\theta^2 + \sin^2\theta d\phi^2)$
	$x = ct$

Following, the study of corresponding radial geodesics.

(t) $F = (1 - \frac{R_s}{r}) \dot{x}^2 - (1 + \frac{R_s}{r}) \dot{t}^2 - 2 \frac{R_s}{r} \dot{x} \dot{t}$	matter	Fold F
(u) $1 = (1 - \frac{R_s}{r}) \dot{x}^2 - (1 + \frac{R_s}{r}) \dot{t}^2 - 2 \frac{R_s}{r} \dot{x} \dot{t}$		photons
(v) $\frac{d}{ds} \left(\frac{\partial F}{\partial \dot{\alpha}^i} \right) = \frac{\partial F}{\partial \alpha^i}$		null geodesics
$\dot{x} = \frac{\lambda r + R_s \dot{t}}{r - R_s}$ $\dot{t} = v \sqrt{\lambda^2 - 1 + \frac{R_s}{r}}$		$(1 - \frac{R_s}{r}) c^2 dt^2 - (1 + \frac{R_s}{r}) dr^2 - \frac{2 R_s}{r} c dt dr = 0$
$x = ct$ $r \rightarrow \infty \quad \frac{dr}{ds} \rightarrow 0 \quad \lambda = 1$		$v_\phi = c \frac{v - \frac{R_s}{r}}{1 + \frac{R_s}{r}} \quad v = -1 \quad v_\phi = -c$
$\frac{dt}{dr} = \frac{v}{c} \frac{r + R_s v \sqrt{\frac{R_s}{r}}}{(r - R_s) \sqrt{\frac{R_s}{r}}}$ $v = +1 \quad \Delta t \rightarrow \infty$ $v = -1 \quad \Delta t \text{ finite}$		
$v = -1 ; r \rightarrow R_s \quad \frac{dr}{dt} \rightarrow -\frac{2c}{3}$		

We use Lagrange equations. On the right we see that the speed of light, following radial paths has two values. $v = -1$ corresponds to centripetal paths: the speed has a constant value $-c$. Similarly (left) the transit time from a distant point to the Schwarzschild sphere depends on the orientation of the paths. Centripetal ($v = -1$) free fall time is achieved in finite time interval Δt . Oppositely a centrifugal path ($v = +1$), starting from the Schwarzschild sphere gives an infinite time interval, so that the Schwarzschild sphere works like a one-way membrane. This corresponds to a *radial frame-dragging effect*. This is not a reason to reject this interpretation of the Schwarzschild geometry. In effect we find a similar phenomenon in the Kerr metric (*azimutal frame-dragging*). Next, the classical expression of the Kerr metric. We see that we get two distinct values for azimutal speed of light. Depends if we consider light following the rotation or going backwards.

Kerr metric	$ds^2 = (1 - \frac{2m\rho}{\rho^2 + a^2 \cos^2 \theta}) dx^2 - \frac{\rho^2 + a^2 \cos^2 \theta}{\rho^2 + a^2 - 2m\rho} d\rho^2 - (\rho^2 + a^2 \cos^2 \theta) d\theta^2$ $- [(\rho^2 + a^2) \sin^2 \theta + \frac{2ma^2 \sin^4 \theta}{\rho^2 + a^2 \cos^2 \theta}] d\phi^2 - \frac{4m\rho a}{\rho^2 + a^2 \cos^2 \theta} dx^\alpha d\phi$
Speed of light (azimutal frame-dragging)	$v_\phi = \frac{\rho d\phi}{dt} = c \frac{-2m a \pm \rho \sqrt{\rho^2 - 2m\rho + a^2}}{\rho^2 + a^2 + \frac{2ma^2}{\rho}}$

We can give a new interpretation of the Schwarzschild geometry, through a space-bridge linking two folds F and \underline{F} . If the fold \underline{F} corresponds to the twin fold, the time coordinate $\underline{t} = -t$ (T-symmetry). From section 19 we know that this T-symmetry goes with a mass-inversion, so that when a positive mass passes through the Schwarzschild sphere, considered as a throat surface, the sign of it becomes negative. The conjugated geometry, as presented in section 13 corresponds to change R_s into $-R_s$.

Then we introduce the following Eddington-like time marker change:

${}^{(r)}x^0 = \underline{x} - R_s \text{Log} \left \frac{r}{R_s} + 1 \right $	${}^{(s)}ds^2 = \left(1 + \frac{R_s}{r}\right) c^2 dt^2 - \left(1 - \frac{R_s}{r}\right) dr^2 - 2 \frac{R_s}{r} c dt dr - r^2 (d\theta^2 + \sin^2\theta d\phi^2)$
$\underline{x} = c \underline{t} = -ct$	

Still using Lagrange's equation we study the radial geodesics system and build a link between the two folds. A test particle can go from fold F to the twin fold F in a finite time Δt , passing through the throat surface: the Schwarzschild sphere. But the inverse paths requires an infinite time, so that it is a one-way passage from a Universe to the other. Here again we find a frame-dragging effect, in the opposite direction.

During the transit the proper time flow is unchanged: $ds > 0$. This makes the black hole model questionable. In effect, according to this new interpretation of the Schwarzschild geometry such space bridge can swallow in a very short time ($\approx 10^{-4}$ sec) unlimited amounts of matter. By the way, an analysis based on the Kerr metric, although a little bit more complicated gives similar results.

${}^{(w)}E = \left(1 + \frac{R_s}{r}\right) \dot{\underline{x}}^2 - \left(1 - \frac{R_s}{r}\right) \dot{r}^2 - 2 \frac{R_s}{r} \dot{\underline{x}} \dot{r}$		<div style="border: 1px solid black; display: inline-block; padding: 2px 10px;">Fold F</div>
${}^{(x)}1 = \left(1 + \frac{R_s}{r}\right) \dot{\underline{x}}^2 - \left(1 - \frac{R_s}{r}\right) \dot{r}^2 - 2 \frac{R_s}{r} \dot{\underline{x}} \dot{r}$	<div style="border: 1px solid black; display: inline-block; padding: 2px 10px;">matter</div>	
${}^{(y)}\frac{d}{ds} \left(\frac{\partial E}{\partial \dot{\alpha}^i} \right) = \frac{\partial E}{\partial \alpha^i}$		<div style="border: 1px solid black; display: inline-block; padding: 2px 10px;">photons</div>
$\dot{\underline{x}} = \frac{\lambda r + R_s \dot{r}}{r + R_s} \quad \dot{r} = v \sqrt{\lambda^2 - \left(1 + \frac{R_s}{r}\right)}$		<div style="border: 1px solid black; display: inline-block; padding: 2px 10px;">Fold F</div>
$\underline{x} = c \underline{t} \quad \underline{t} = -t \quad ds > 0 \quad r \rightarrow \infty \quad \dot{\underline{x}} \rightarrow \lambda < 0$		$\left(1 + \frac{R_s}{r}\right) c^2 dt^2 - \left(1 - \frac{R_s}{r}\right) dr^2 - 2 \frac{R_s}{r} c dt dr = 0$
$\frac{dt}{dr} = \frac{v}{c} \frac{\lambda r + v R_s \sqrt{\lambda^2 - \left(1 + \frac{R_s}{r}\right)}}{(r + R_s) \sqrt{\lambda^2 - \left(1 + \frac{R_s}{r}\right)}}$		$v_\phi = c \frac{v - \frac{R_s}{r}}{1 - \frac{R_s}{r}} \quad v = +1 \quad v_\phi = c$
$\underline{\lambda} = -1.63 \quad \underline{\lambda}^2 > 2$		

Following, the solution of the geodesic systems.

<div style="border: 1px solid black; display: inline-block; padding: 2px 10px;">Fold F</div> $d\phi = \pm \frac{dr}{r^2 \sqrt{\lambda^2 - 1 + \frac{R_s}{h^2 r} - \frac{1}{r^2} + \frac{R_s}{r^3}}}$	<div style="border: 1px solid black; display: inline-block; padding: 2px 10px;">Fold E</div> $d\phi = \pm \frac{dr}{r^2 \sqrt{\lambda^2 - 1 - \frac{R_s}{h^2 r} - \frac{1}{r^2} - \frac{R_s}{r^3}}}$
$\text{tg } \alpha = \left[\frac{rd\phi}{dr} \right]_{r \rightarrow R_s} \longrightarrow \frac{h}{R_s^2 c l}$	

How to figure such paths? We can use the initial (r, θ, φ) representation space. Then we get the above system of differential equations and the schema of figure 27.

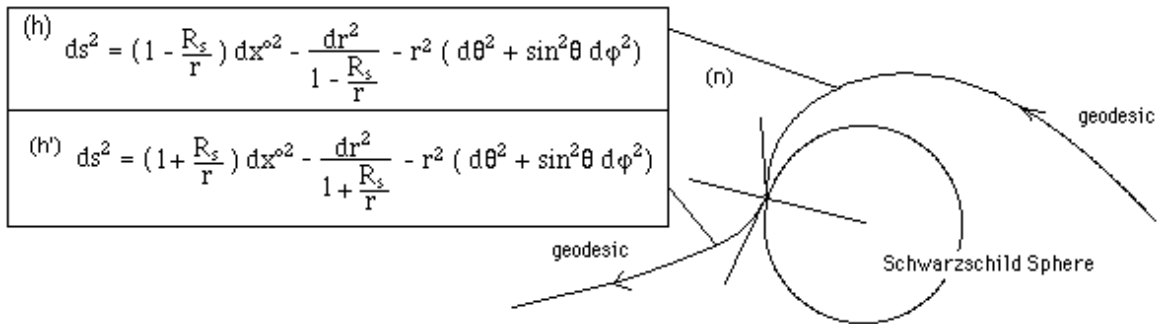
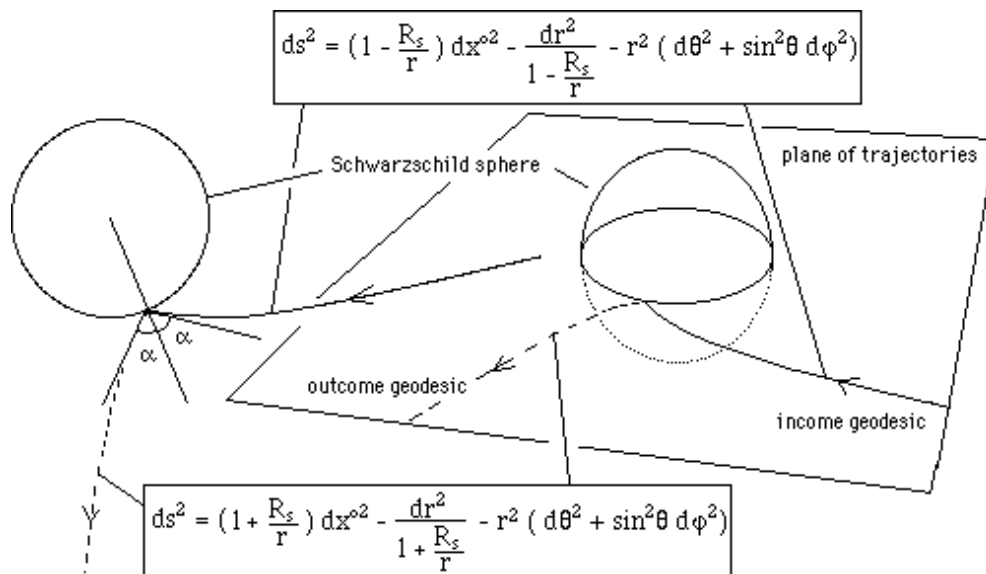

Fig.27: Income and outcome geodesics.

The geodesic seems to “bounce” on the Schwarzschild sphere, as shown of figure 28 too.



**Fig. 28: Plane trajectory, as figured in a (r, θ, φ) representation.
The income geodesic is in fold F, while the outcome is in the twin fold \bar{F} .
In fold F the structure attracts the test particle. In the twin fold, it is repelled.**

But all that comes from such naïve Euclidean representation of the path. Using the following change of space marker:

$$r = R_s + \text{Log ch } \rho$$

The expression of joint metrics become:

$ds^2 = \frac{\text{Log ch}\rho}{R_s + \text{Log ch}\rho} c^2 dt^2 - \frac{2R_s + \text{Log ch}\rho}{R_s + \text{Log ch}\rho} \text{th}^2\rho d\rho^2$	$r \rightarrow R_s \quad \rho \rightarrow \pm 0$
Fold F $- \frac{2 R_s c \text{ th}\rho}{R_s + \text{Log ch}\rho} d\rho dt - (R_s + \text{Log ch}\rho)^2 (d\theta^2 + \sin^2\theta d\varphi^2)$	
$ds^2 = \frac{2R_s + \text{Log ch}\rho}{R_s + \text{Log ch}\rho} c^2 dt^2 - \frac{\text{Log ch}\rho}{R_s + \text{Log ch}\rho} \text{th}^2\rho d\rho^2$	$\text{tg } \beta = \left[\frac{\rho d\varphi}{d\rho} \right]_{\rho \rightarrow \pm 0} \longrightarrow \frac{h}{R_s^2 c l} \rho^2$
Fold E $- \frac{2 R_s c \text{ th}\rho}{R_s + \text{Log ch}\rho} d\rho dt - (R_s + \text{Log ch}\rho)^2 (d\theta^2 + \sin^2\theta d\varphi^2)$	

We have figured the pitch angle, which tends to zero when the geodesic passes from the F fold ($\rho > 0$) to the twin fold E ($\rho < 0$) and ensures the continuity of the geodesic line. On figure 30 we have given a 2d didactic image of such space bridge linking a portion of posicone and the conjugated portion of a negacone. There, the Schwarzschild sphere becomes a simple circle.

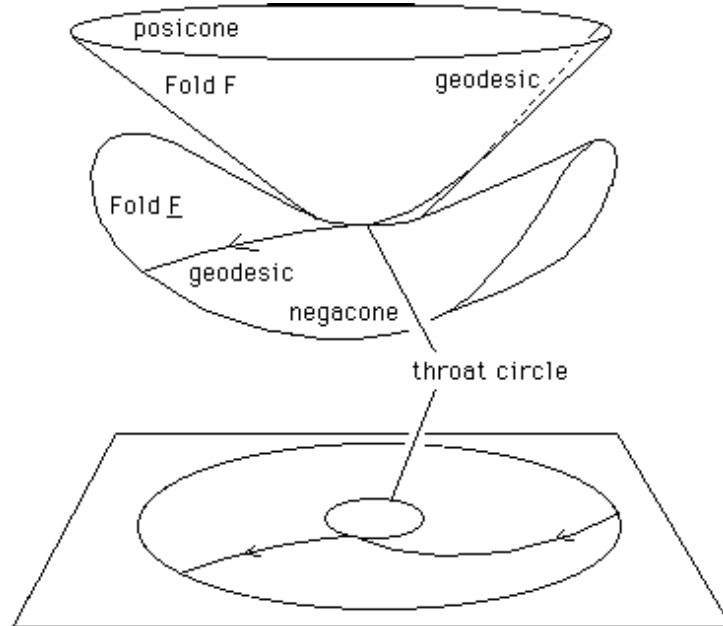

Fig. 29: Didactic image of a fast flow space bridge.

References.

- [1] J.F. Augereau: « Si la matière sombre dévie les rayons lumineux, c'est donc qu'elle existe » (If dark matter bends light rays it shows it does exist). Le Monde, March 17th 2000.
- [2] Interview of B. Fort in Ciel et Espace, June 2000.
- [3] J.P. Petit: The missing mass effect. Il Nuovo Cimento, B, vol. 109, July 1994, pp. 697-710
- [4] J.P. Petit, Twin Universe Cosmology. Astrophysics and Space Science. Astr. And Sp. Sc. **226**: 273-307, 1995
- [5] Zel'dovich Ya.B., Astrophysica 6. 319 MNRAS **192**, 192(1970)
- [6] Doroskevich A.G. MNRAS **192**, 32 (1980)
- [7] Klypin A.A & Shandarin S.F. MNRAS **204**, 891 (1983)
- [8] Centrella J.M. & Mellot A.L. Nature **305**, 196 (1983)

- [9] Mellot J.M. & Shandarin S.F. *Nature* **346** , 633 (1990)
- [10] Shandarin S.F. In *Large Structures of the Universe*, ed. J.Audouze, M.C. Peleton and A.Szalay, 273. Dordrecht: Kulwer (1988).
- [11] Kofman. L.A., Pogosyan D. and Shandarin S. *MNRAS* **242**, 200 (1990)
- [12] Peebles P.J.E. *Principles of Physical Cosmology*, Princeton University Press (1993).
- [13] M. Myamoto and R. Nagai *Publ. Astrom. Soc. Japan* **27**, 583, 1975
- [14] J. Binney and S. Tremaine, "*Galactic Dynamics*", Princeton University Press, Princeton, 1987. [16] Bahcall J.N & Soneira R.M. *APJ. S* **44** p. 73 1980
- [17] Bahcall J.N., Flynn A and Gould A. *APJ* **389** p.234 1992
- [18] B. Lindblad, *Handbuch der Physik* **53**, (1959) 21
- [19] C.C. Lin and F.H. Shu: *Astrophysics and Gen. Relat. Vol.2* Gordon and Breach Sc. Publ. 1971, p. 235
- [20] Toomree A. (1981) *The structure and dynamics of normal galaxies*. Cambridge University Press, p.111
- [21] Toomree A. and Toomree J. (1972) *Astrophys. J.* **178**, 623 & *Rev. Astronom. Astrophys.* **15** (1977) 437
- [23] E. Athanassoula: *Companion driven spirals and bars*. International Astronomic Union. Symposium n° 146 (1991)
- [24] A. Toomree *Astrophys. J.* **158** (1969) 89
- [25] R. H.Miller and B.F. Smith, *Astrophys. J.* **277** (1979) 785
- [26] F. Hohl, *Astrophys. Sp. Sc.* **14** (1971) 91
- [27] Holmberg E. (1941) *Astrophys. J.* **94**,
- [28] B. Sundelius and K.J. Donner: *Interaction galaxies, Dynamics of Disk Galaxies* (1991) Sundelius ed. p. 195
- [29] S. Engström: *Feature velocitys in numerical simulations. , Dynamics of Disk Galaxies* (1991) Sundelius ed. p. 332
- [30] A.Toomree *Ann. Rev. Astron. Astrophys.* **15** (1977) 437.
- [31] F. Bouchet and L. Hernquist: *Cosmological simulations using theoretical tree methods. Astr. Jr Suppl. Series* 68, pp. 521, 538, 1988.
- [32] F. Bouchet, L. Hernquist and Y.Suto: *Application of the Ewald method to cosmological N-body simulation. Apj. Suppl. Series* **75** , pp. 231-240, 1991
- [33] A. Sakharov: "*CP violation and baryonic asymmetry of the usniverse*". *ZhETF Pis'ma* **5**: 32-35 (1967): Traduction *JETP Lett.* **5**: 24-27 (1967)
- [34] A. Sakharov: "*A multisheet Cosmological Model*" Preprint
- [35] A. Sakharov: "*Cosmological Model of the Universe with a time-vector inversion*". *ZhETF* **79**: 689-693 (1980): Traduction in *Sov. Phys. JETP* **52**: 349-351 (1980)
- [36] A. Sakharov: "*Topological structure of elementary particles and CPT asymmetry*" in "*problems in theoretical physics*", dedicated to the memory of I.E. Tamm, Nauka, Moscow 1972, pp. 243-247
- [37] Green M.B. & Schwarz J.H. *Nucl. Phys.* **B181**, 502-530 (1981) ; **B198**, 225-268 (1982) ; *Phys. Lett. B*, 444-448 (1982)
- [38] Green M.B. *Surv. High Energy Phys.* **3**, 127 (1982) & Rohm R. , *Phys. Rev. Lett.* **54**, pp 503-505 (1985)
- [40] Kolb E.W., Seckel D , Turner M.S.: *The shadow world of superstring theories, Nature* Vol. 314, April 1984, pp. 415-419
- [41] P.C.W.Davies & J.B.Brown: *Superstrings*, Cambridge University Press, 1988
- [42] Abdus Salam, *Nuovo Cimento* **5**, 299 (1957)
- [43] Nima-Arkani Ahmed, Savas Dimopoulos and Georgi Dvali: "*Les dimensions cachées de l'univers*", *PLS*, Oct 2000, n° 276, pp. 56-64
- [44] J.P. Petit: *An interpretation of cosmological model with variable light velocity. Modern Physics Letters A*, Vol. 3, n°16, Nov 1988, p.1527
- [45] J.P. Petit: *Cosmological model with variable light velocity: the interpretation of red shifts. Modern Physics Letters A*, Vol.3 , n° 18, Dec. 1988, p.1733
- [46] J.P. Petit & M. Viton: *Gauge cosmological model with variable light velocity. Comparizon with QSO observational data. Modern Physics Letters A* Vol.4 , n°23 (1989) pp. 2201-2210
- [47] P.Midy & J.P. Petit: *Scale Invariant Cosmology. The international Journal of Modern Physics D*, Vol.8 June 1999 pp.271-280
- [48] E.A. Milne: *Kinematic Relativity* Oxford 1948.
- [49] J.D. Anderson, P.A. Laing, E.L.Lau, A.S.Liu, M.M. Nieto and S. Turchev: *Indication for Pioneer 10/11, Galileo and Ulysse Data, an an Apparent Anomalous, Weak, Long-Range Acceleration. Phys. Rev. Letters: 81* 31 August 1998.
- [50] G.J. Stephenson Jr., T. Goldman, *Phys. Rep.* **205**, 211 (1992) ; **216**, 343 (1992).
- [51] M.N. Nieto and T. Goldman, *Phys. Re.* **205**, 221, 1991; **216**, 343.
- [52] R. Adler, M. Bazin & M. Schiffer: *Introduction to general relativity*, Mac Graw Hill book, 1975, chapter 10, section 10.5: *Classical limit of gravitational equations*, p. 345.
- [53] J.M. Souriau, *Structure des Systèmes Dynamiques*, Ed. Dunod, 1970, France & *Structure of Dynamical Systems*, Birkhauser Ed. Boston-Zurich, 1997.
- [53] J.P. Petit: *Univers énantiomorphes à flèches du temps opposés (Enantiomorphic universes with opposite time arrows)*. *Comptes rendus de l'Académie des Sciences de Paris*, t.284, pp. 1977
- [54] Eddington S.A: *A comparizon of Withead's and Einstein's formulæ. Nature* **113**: 192 (1924).